



Collar Nuts

strength class 10



Nuts

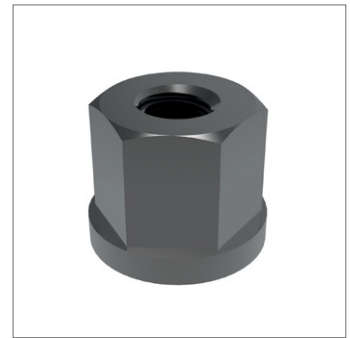
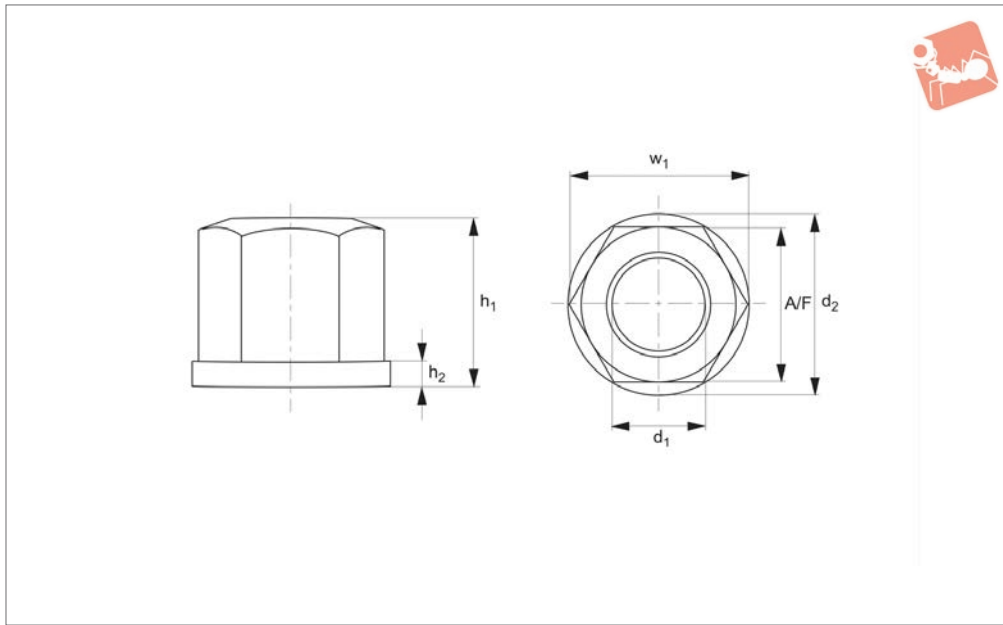

24400

NUTS

Material

Steel, heat treated. Tensile strength class 10. Turned and milled.

Technical Notes

Produced to DIN 6331.

Order No.	d_1	w_1	$h_1 = 1,5 \times d_1$	d_2	h_2	A/F	Weight g
24400.W0106	M 6	11.1	9	14	3.0	10	6
24400.W0108	M 8	14.4	12	18	3.5	13	12
24400.W0110	M10	17.8	15	22	4.0	16	21
24400.W0111	M10	18.9	15	22	4.0	17	25
24400.W0112	M12	20.0	18	25	4.0	18	30
24400.W0113	M12	21.1	18	25	4.0	19	36
24400.W0114	M14	23.4	21	28	4.5	21	43
24400.W0115	M14	24.5	21	28	4.5	22	51
24400.W0116	M16	26.8	24	31	5.0	24	70
24400.W0118	M18	30.1	27	34	5.0	27	95
24400.W0120	M20	33.5	30	37	6.0	30	130
24400.W0122	M22	37.7	33	40	6.0	34	200
24400.W0123	M22	35.7	33	40	6.0	32	160
24400.W0124	M24	40.0	36	45	6.0	36	230
24400.W0127	M27	45.6	40	50	8.0	41	320
24400.W0130	M30	51.3	45	58	8.0	46	470
24400.W0136	M36	61.3	54	68	10.0	55	800
24400.W0142	M42	72.6	63	80	12.0	65	1340
24400.W0148	M48	83.9	72	92	14.0	75	2040



Nuts

Available in heat treated steel, unless stated otherwise.

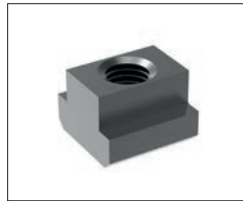

24000 T-Nut, Strength Class 10 DIN 508.

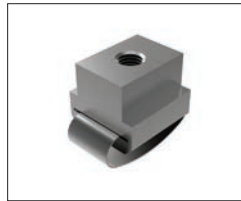

24010 T-Nut with Anti-Slip Device.

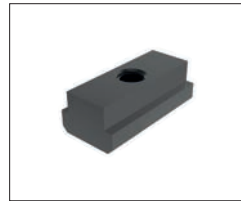

24100 Extended T-Nut. Strength Class 10.

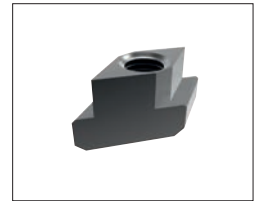

24120 Rhombus T-Nuts

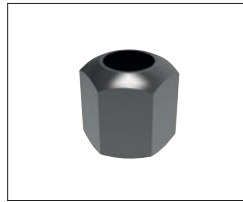

24300 Fixture Nuts. Strength Class 10 - DIN 6330B

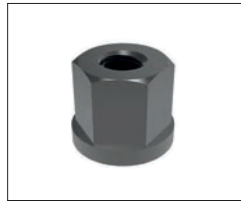

24400 Collar Nuts, DIN 6331

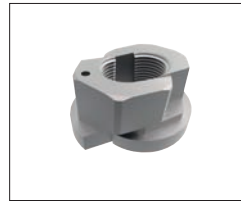

24502 Fast Nut - With Collar Rapid Assembly Nut

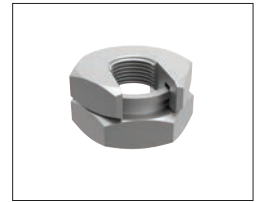

24520 - Steel Slip-On Lock Nuts - Rapid Assembly Nut.



24600 Extension Nuts Strength Class 10.



24620 Swivel Nuts, Conical Seat

Washers

Available in a range of steel types - see product for details.



25000 - Hardened Steel - Plain Washers. DIN 6340.



25100 - Case Hardened Steel - Spherical Seat Washers. Type C - DIN 6319C.



25400 - Case Hardened Steel - Dished Washers, Type D - DIN 6319D.



25700 - Tempered Steel - Dished Washers, Type G - DIN 6319G.



25900 - Stainless Steel Compact Spherical Washer, Conical Seat, similar to DIN6319