

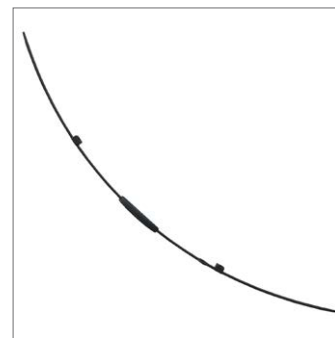

Lanyard - Cable Tie Loop

thermoplastic

Ball Lock Pins & Quick Release

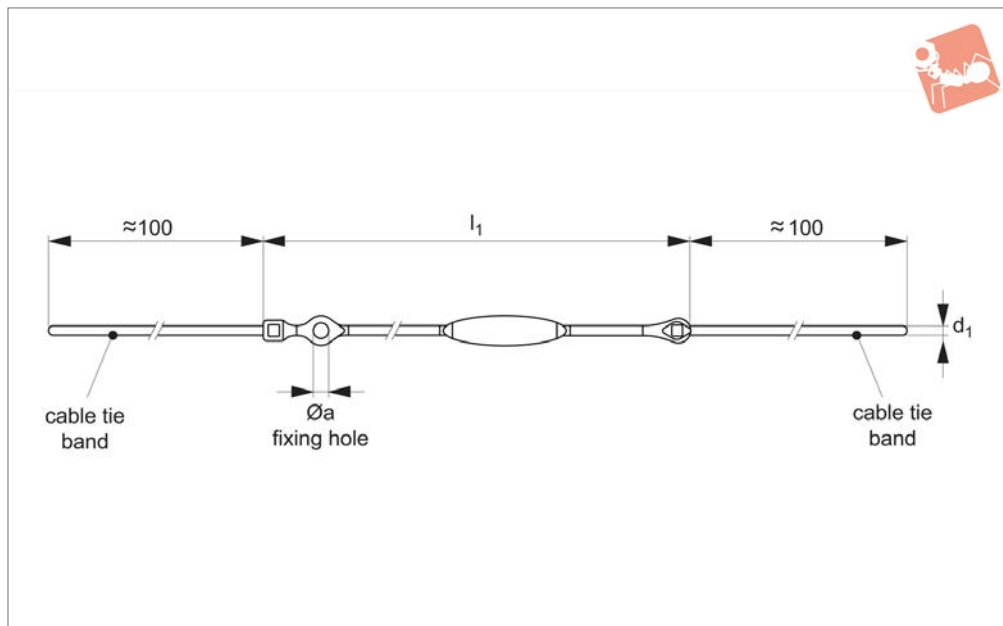

33260

BALL LOCK PINS & QUICK RELEASE PINS

Material

Thermoplastic PA6, grey.

Technical Notes

Temperature range up to 80°C offers two

fixing alternatives:

- Cable tie at both ends
- Cable tie one end and fixing hole at other to secure with M4 screw.

Tips

For use in securing components to assemblies, or to avoid items being misplaced.

Order No.	Coating	d ₁	l ₁	Ø a	Weight g
33260.W0970	n/a	2.5	150	4.2	2.1
33260.W0974	n/a	2.5	250	4.2	2.7



Sound Rigging Systems

Ball lock pins on a sound rigging system. Offering secure fixing with high shear forces and easy fitting for operators at heights.

In addition full black powder coating of grip and actuation button eliminates glare from other stage lighting.



BALL LOCK PINS & QUICK RELEASE PINS

Gym Equipment

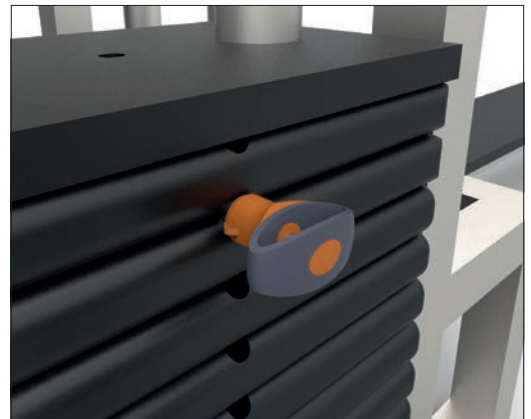

Scientific and Medical

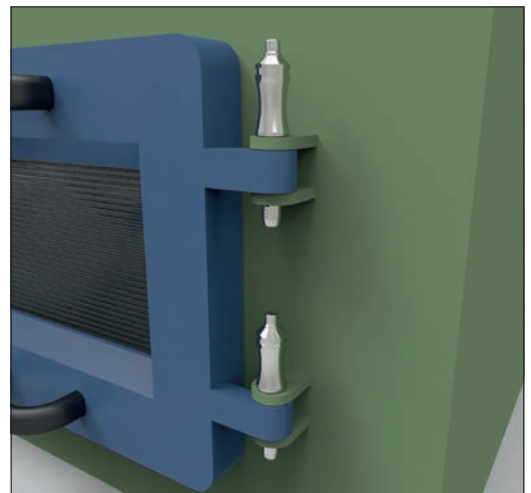
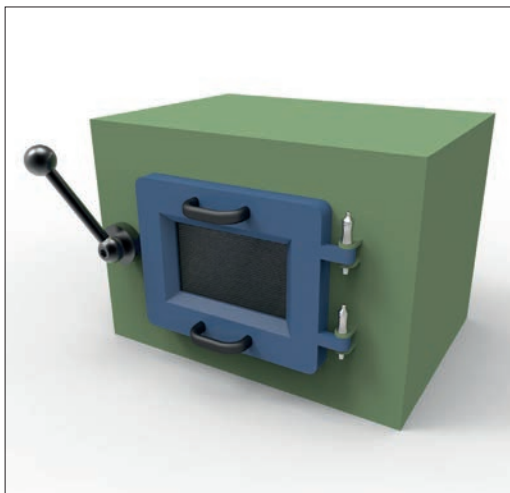



Wixroyd Ball Lock Pins

features

33060 - 33250

Positioning Elements

BALL LOCK PINS & QUICK RELEASE PINS

1.4305 (AISI 303) - shear force approx. 60% of higher material version 1.4542

1.4542 (AISI 630) - identified by the ridge on the pin

CRES 17-4PH (AMS 5643) aviation standard



Pin Material



Handle Style

Plastic tri-star T-handled, metal L-handled, metal Mushroom, metal Single piece metal, contoured



Special plastic self-spring Adjustable grip length, plastic Key ring Safety, metal Mushroom Type B aviation Type R aviation



Lanyards and Locating Bushes

Stainless wire - (coated) - 2 x key ring Stainless wire - Key ring and fixing loop Plastic - 2 x cable tie Steel wire - (coated) - 2 x key ring Stainless bead chain - 2 x key ring Locating bushes



Actuation

Press = unlock
Release = lock (standard)

Press = unlock and position
Release = lock and simultaneous clamp

Simple spring loaded balls "pullout pin"

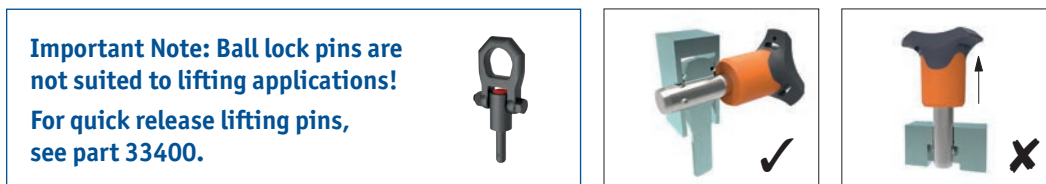

Important Note

Important Note: Ball lock pins are not suited to lifting applications!

For quick release lifting pins, see part 33400.

Shear force

Lifting force



Special Variations

Variations on our standard designs are possible, please contact our sales team for technical assistance. Quick production on specials can be as little as 3 weeks.



Applications

- Positioning.
- Lifting.
- Locking.
- Indexing.
- Joining.

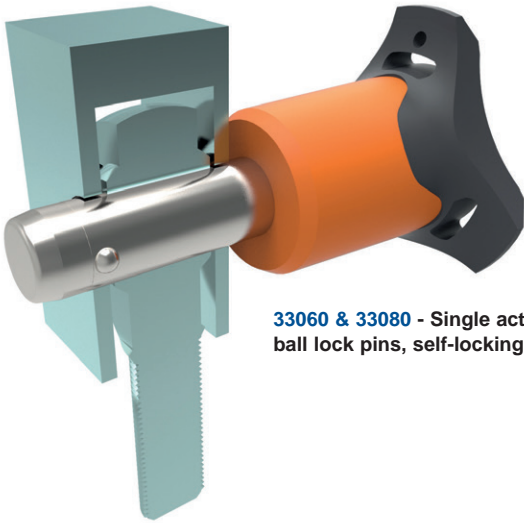

33060 & 33080 - Single acting ball lock pins, self-locking.



33194 - Single acting ball lock pins, self locking, simple finish.



33140 - Socket pins, non-locking, spring loaded balls.



33100 - Single acting ball lock pin, self locking.



33180 - Clamping pins, with span compensation, self-locking.

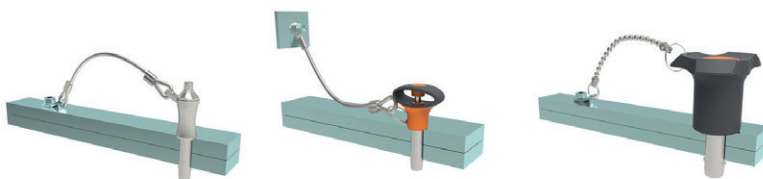

33250 & 33270 - Lanyards.



33220 - Ball lock pins, single acting - L-handle