



# Waterproof Seal Washers

304 stainless steel



## Sealing Screws

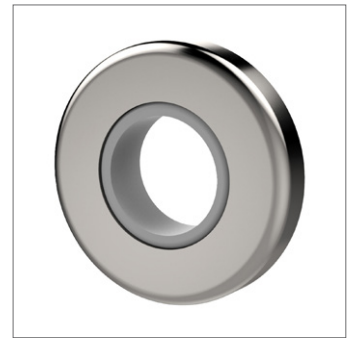
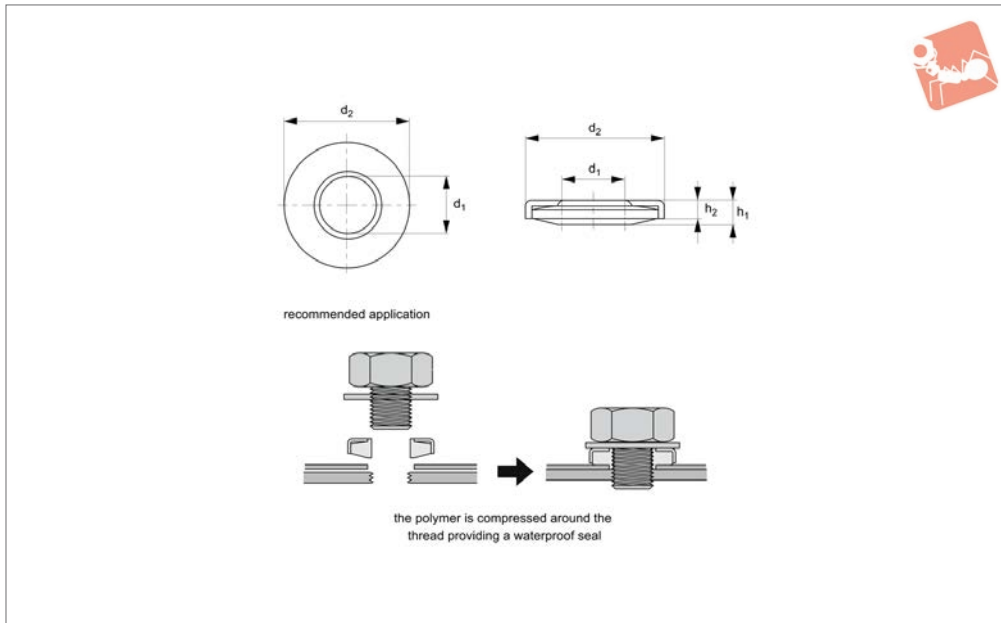

**36637**

SEALING SCREWS

### Material

Stainless steel (AISI 304, 1.4301), with thermoplastic elastomer (TPE) insert.

### Technical Notes

Seals substances in and contaminants out. For watertight applications, the seal is best

placed against a smooth material, ensuring a tight seal is created.

### Tips

We recommend installing a flat washer above the sealing washer to ensure that uniform pressure is applied to the elas-

tomer inside the washer. We recommend that you test the sealing washer in your application to determine the optimum tightening torque. For use at -30 °C to 90 °C.

Order No.	For thread	d <sub>1</sub>	d <sub>2</sub>	h <sub>1</sub>	h <sub>2</sub>	Recommended tightening torque Nm	Rated pressure (liquids) Bar max.	Rated pressure (gases) Bar max.	Weight g
<b>36637.W0030</b>	M 3	3.0	8	3.1	2.5	0,3-0,6	7	7	0.4
<b>36637.W0040</b>	M 4	4.1	10	3.5	3.0	0,8-1,5	7	7	0.6
<b>36636.SP005</b>	M 5	5.1	12	3.5	3.0	1,5-3,0	7	7	1.0
<b>36637.W0060</b>	M 6	6.1	14	3.5	3.0	2,5-5,0	7	7	1.0
<b>36636.SP006</b>	M 8	8.1	18	4.0	3.0	6,2-12	7	7	2.0
<b>36637.W0100</b>	M10	10.1	23	4.0	3.0	24-12	7	7	3.0
<b>36637.W0120</b>	M12	12.1	25	4.0	3.0	21-42	7	7	4.0
<b>36637.W0160</b>	M16	16.1	30	4.5	3.0	53-106	7	7	6.0
<b>36637.W0200</b>	M20	20.1	37	4.5	3.0	103 min.	7	7	9.0

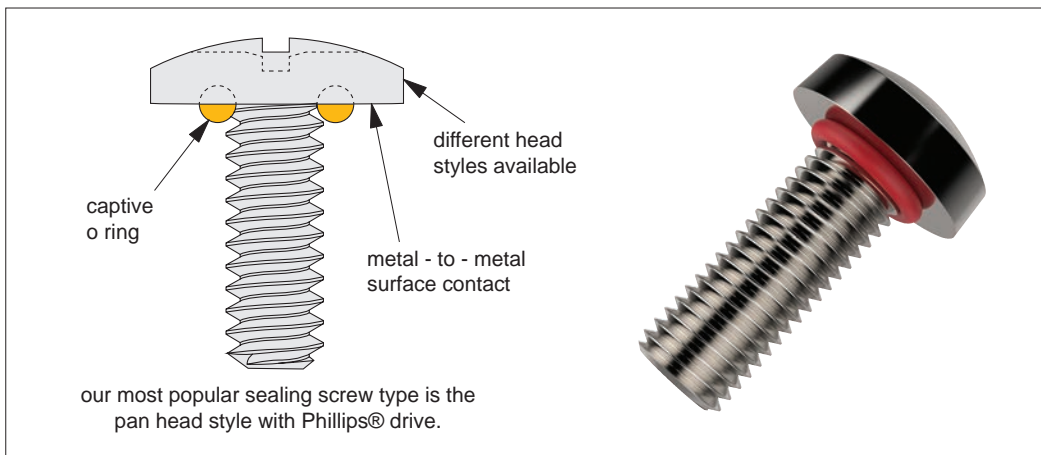

SEALING SCREWS

## Why use Sealing Screws?

An ordinary screw lacks seal protection, allowing dirt, fluids, gases etc to infiltrate and damage sensitive devices. Sealing screws provide bi-directional sealing protection to systems where screws are used, to protect them against dirt, chemicals, water or other contaminants, which (without the screw seal), may penetrate and cause damage, or alternatively where gases and liquids may leak out.

Sealing screws are designed and manufactured with a precision engineered groove beneath the head of the fastener to accommodate the integral O-ring. As the fastener is tightened, the O-ring is compressed, squeezing it between the groove and mating surface to complete the seal. The design of the groove controls the amount of compression of the O-ring, and because O-rings retain their elastic memory, the screws are reusable time after time.

The seal provides bi-directional sealing which provides a total barrier seal against internal or external conditions (water, fluids, chemicals, dirt, air, contaminants etc) which could otherwise penetrate and damage systems. The screws are very easy to use and do not need any special preparation or re-tightening.

There are a range of O-ring materials that can resist virtually all chemical and environmental conditions. We can also provide sealing screws (on request) to military specifications (MILSPEC).

## Sealing Screw Heads

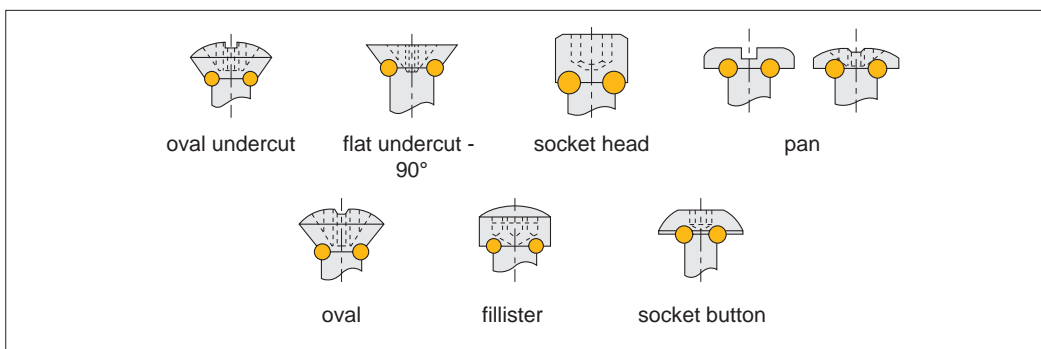

## Ordering Options



**36630 - Pan head - Phillips® Security and Torx® options**

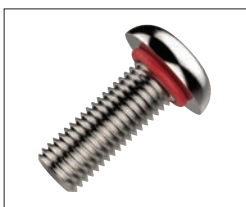

**36631 - Button Hex-head Security and Torx® options**

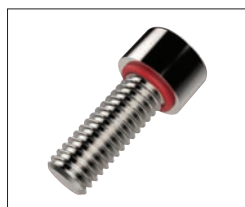

**36633 - Socket Head Security and Torx® options**

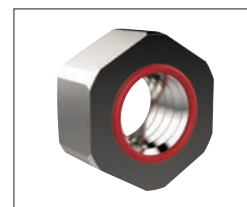
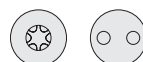

**36636 - Hexagon Nut**



### Optimal performance

When using self-sealing screws a high pressure seal is formed along the thread's contact surface when torqued.

If possible, and to ensure maximum sealing performance, we recommend a clearance hole (see table below), this creates room for the O-ring to flow into.

The aim is to ensure full metal-to-metal contact between the underside of the fastener and the mounting surface.

If a clearance hole cannot be utilized, the O-ring will still function as it will compress to fill the gap between the male and female surfaces.

We also have a range of sealing nuts to complement our range of sealing screws. These sealing nuts often eliminate the need for gaskets, compounds and surface preparation. They are widely used in the hydraulic, pneumatic or fuel systems industries.

They are invaluable when a vacuum needs to be created and provide a complete seal when gaseous or liquid pressure is a factor. Domed nuts are self-sealing and provide exceptional vibration resistance.

Some of the typical applications for our sealing screws include:

- Motors
- Cabinets and enclosures
- Sensors and instrumentation
- Internal combustion engines
- Gear pumps
- Fuel tanks
- Transmissions
- Gear boxes
- Air cylinders
- Pressure gauges
- Computer disk drives
- Motion control valves
- Missile tanks
- Wet wings

### Self-sealing Screw

### Applications

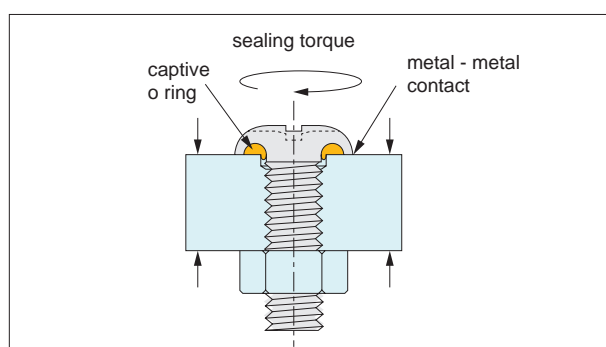

Thread Size	Standard Installation Torque
M3	0.6 Nm
M3.5	1.0 Nm
M4	2.2 Nm
M5	2.5 Nm
M6	8.5 Nm
M8	16 Nm
M10	30 Nm

### Installation Torque

Nom. Size	Max clearance hole Ø
M2	2,44
M2,5	2,95
M3	3,45
M3,5	3,66
M4	4,55
M5	5,56
M6	6,66
M8	9,04
M10	11,05
M12	14,05
M14	16,05
M16	18,06

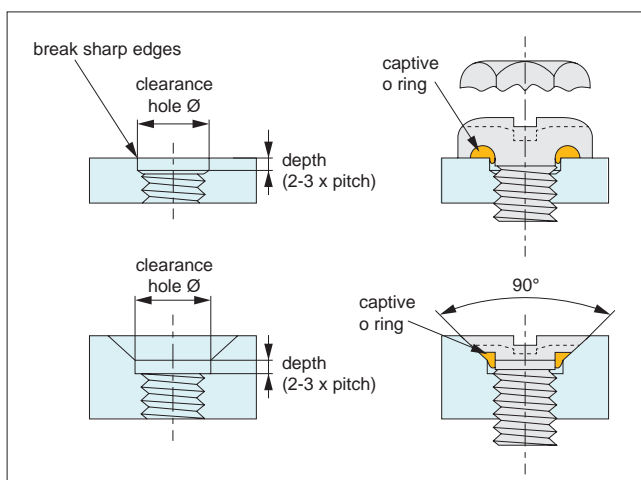





### Clearance Hole Ø - Recommended

For optimal seal screw performance we recommend creating a clearance hole in the panel into which the O-ring can be fitted. This causes the O-ring to create a complete seal, and the clearance hole thus prevents extrusion into the metal when the screw is under pressure.

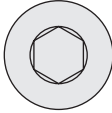

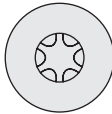
## Drive Types

Schematic	Drive Types	Uses
	Hexagonal	Ideal for precision assembly. Most recommended where less surface area is available.
	Cross Drive (Phillips®)	Most recommended drive type. Provides good control in driving. Always use a driver bit of the proper size which is in good condition.
	Hexalobular (Torx®)	Positive-engaging, fast-locating method which transmits drive torque with less required downward pressure. Good fastening appearance.
	Security	These screws are impossible to remove without the special matching screwdriver.

We can provide Torx® heads and security/tamper-proof screws, as well as special threads, grooves and cross holes for safety wires, and a further range of styles such as captive screws, anti-vibration strips on the threads etc (for extreme vibration applications).

## O ring Selection

Standard O rings are red silicone, but a further five O ring material types are readily available. The main factor to consider when selecting an O ring type is the environment in which it will be placed, and the temperature range it will be subjected to.

Material	Notes
Silicone (SI)	Our standard O ring type with a wide temperature range -60°C to +200°C. Resistant to moderate or oxidising chemical, but not generally oil or solvent resistant.
Fluorosilicone (FS)	Widely used in the automotive and aerospace industries as it has excellent resistance to fuel, oil and solvents. Standard temperature range -50°C to +170°C.
EPDM (EP)	These O rings are very suited for outdoor environments and are good for weather and water resistant applications having excellent ozone, steam and chemical resistance. Temperature range -50°C to +110°C.
Viton-fluorocarbon (VI)	These seals are widely used on aircraft engines and automotive fuel handling systems as they have excellent fuel, oil and solvent resistance. Standard temperature range -50°C to +200°C
Nitrile (NI)	Widely used as highly resistant to petroleum based substances, water and alcohols. Temperature range -50°C to +110°C.

Other O rings types can include Neoprene, Buna N, Teflon etc.



Our standard screw material is stainless steel (AISI 303, 1.4305). Other materials available are aluminium (non-magnetic and 1/3 weight of steel), brass (high electrical conductivity, non-magnetic and good corrosion resistance), titanium (low weight, very strong and highly corrosion resistant), stainless steel (A4, AISI 316).

Fasteners can be supplied to MILSPEC standards (MIL-S-82496A) on request.

Finishes are dependent on the material you are wishing to coat and subject to minimum quantities.

Finish	Notes
Black Chrome (MIL-C-1458B)	Black chrome is a hard, non-reflective coating which is resistant to abrasion, heat and erosion. The black chrome surface is a dull, dark grey and may be waxed or oiled to darken surface.
Black Oxide Coating (MIL-C-13924B)	Black oxide is a uniform black coating for ferrous metals. Generally it is considered a decorative coating and provides only very limited corrosion protection under mild corrosion conditions.
Cadmium	Cadmium is a bright, silvery white plating. Supplementary treatments for Type II can be golden, iridescent, amber, black or olive drab.
Passivate (QQ-P-35/MIL S-500SC)	Passivation is a process designed to remove foreign metals from the surface of stainless and corrosion resistant steels.
Phosphate Coating Light (TT-C-00490B)	Phosphate coating is a light coating for use as a base paint.
Gold (MIL-G-45204B)	Yellow to orange colour depending on proprietary process used. Will range from matt to bright finish depending on base metal. Good corrosion resistance and high tarnish resistance.
Nickel (QQ-N-290A)	Nickel is a corrosion protective plating for steel, zinc and zinc alloys as well as copper and copper alloys.
Zinc (QQ-Z-325C)	The primary use of chromate finishes on zinc is to retard or prevent formation of white corrosion products on zinc surfaces.

## Materials

## Finishes



Shoulder Screws

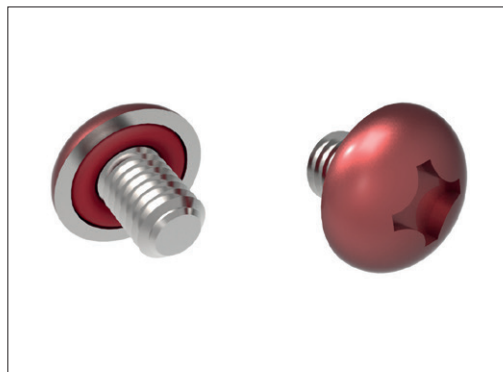

Painted Heads



Captive Screws



Security Heads (Tamper Proof)