



Captive Screws - Countersunk hex drive - 303 stainless

Captive Screws



36684

CAPTIVE SCREWS

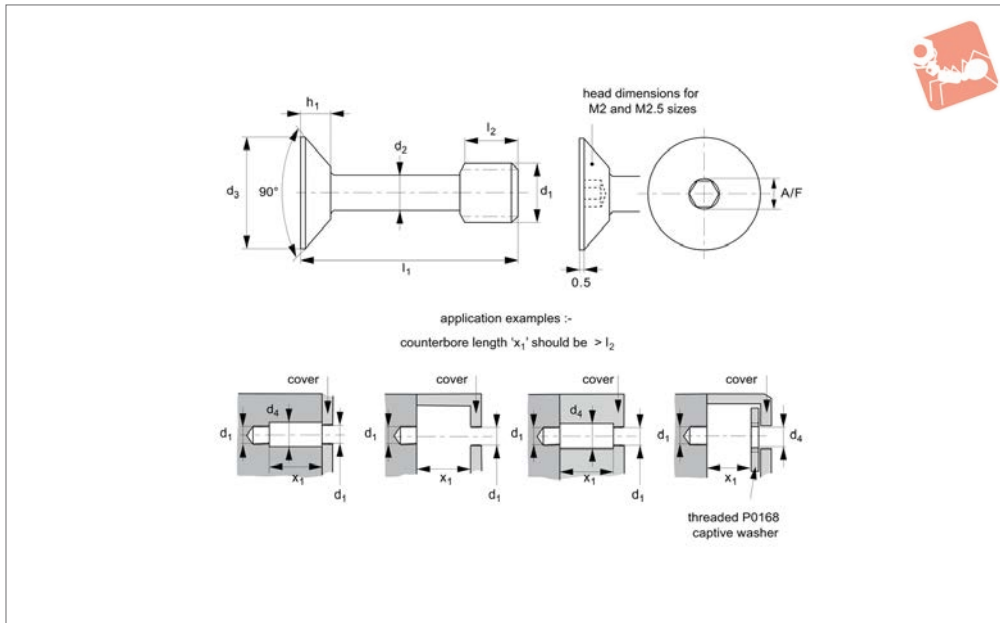

Material

Stainless steel (AISI 303, 1.4305). Tensile strength 550 N/mm². Proof stress min. 190 N/mm², austenitic stainless steel. Also available on request in steel (anodised, black oxide or zinc plated), brass, aluminium etc.

Technical Notes

Used to comply with the Machinery Direc-

tive 2006/42/EC. Often used with our captive washers (36691) or retaining flanges (P0169 - for sheet metal applications). The use of our captive washers should be considered when fitted in panels with unthreaded holes.

Important Notes

Please note that these screws have a reduced diameter shank and should not be

tightened to the recommended torque for an equivalent machine screw of size d₁. To accommodate the slight undercut at the top of the shank, the hex socket is smaller than on a similar threaded machine screw.

Order No.	d ₁	l ₁ ±0.25	d ₂ ±0.12	d ₃ max.	d ₄ min.	h ₁ max.	l ₂ ±0.25	A/F
36684.W0210	M 2	10	1.2	3.8	2.5	1.20	3.5	1.0
36684.W0212	M 2	12	1.2	3.8	2.5	1.20	3.5	1.0
36684.W0216	M 2	16	1.2	3.8	2.5	1.20	3.5	1.0
36684.W0220	M 2	20	1.2	3.8	2.5	1.20	3.5	1.0
36684.W0251	M 2,5	10	1.7	4.7	2.8	1.80	3.7	1.3
36684.W0252	M 2,5	12	1.7	4.7	2.8	1.80	3.7	1.3
36684.W0253	M 2,5	16	1.7	4.7	2.8	1.80	3.7	1.3
36684.W0254	M 2,5	20	1.7	4.7	2.8	1.80	3.7	1.3
36684.W0310	M 3	10	2.0	5.6	3.5	1.65	4.5	1.5
36684.W0316	M 3	16	2.0	5.6	3.5	1.65	4.5	1.5
36684.W0320	M 3	20	2.0	5.6	3.5	1.65	4.5	1.5
36684.W0325	M 3	25	2.0	5.6	3.5	1.65	4.5	1.5
36684.W0330	M 3	30	2.0	5.6	3.5	1.65	4.5	1.5
36684.W0340	M 3	40	2.0	5.6	3.5	1.65	4.5	1.5
36684.W0412	M 4	12	2.8	7.5	4.5	2.20	6.0	2.0
36684.W0416	M 4	16	2.8	7.5	4.5	2.20	6.0	2.0
36684.W0420	M 4	20	2.8	7.5	4.5	2.20	6.0	2.0
36684.W0430	M 4	30	2.8	7.5	4.5	2.20	6.0	2.0
36684.W0440	M 4	40	2.8	7.5	4.5	2.20	6.0	2.0
36684.W0450	M 4	50	2.8	7.5	4.5	2.20	6.0	2.0
36684.W0460	M 4	60	2.8	7.5	4.5	2.20	6.0	2.0
36684.W0512	M 5	12	3.7	9.2	5.5	2.50	7.5	2.5
36684.W0516	M 5	16	3.7	9.2	5.5	2.50	7.5	2.5
36684.W0520	M 5	20	3.7	9.2	5.5	2.50	7.5	2.5
36684.W0525	M 5	25	3.7	9.2	5.5	2.50	7.5	2.5
36684.W0530	M 5	30	3.7	9.2	5.5	2.50	7.5	2.5
36684.W0540	M 5	40	3.7	9.2	5.5	2.50	7.5	2.5
36684.W0550	M 5	50	3.7	9.2	5.5	2.50	7.5	2.5



Order No.	d ₁	l ₁ ±0.25	d ₂ ±0.12	d ₃ max.	d ₄ min.	h ₁ max.	l ₂ ±0.25	A/F
36684.W0560	M 5	60	3.7	9.2	5.5	2.50	7.5	2.5
36684.W0616	M 6	16	4.2	11.0	6.5	3.00	8.0	3.0
36684.W0620	M 6	20	4.2	11.0	6.5	3.00	8.0	3.0
36684.W0625	M 6	25	4.2	11.0	6.5	3.00	8.0	3.0
36684.W0630	M 6	30	4.2	11.0	6.5	3.00	8.0	3.0
36684.W0640	M 6	40	4.2	11.0	6.5	3.00	8.0	3.0
36684.W0650	M 6	50	4.2	11.0	6.5	3.00	8.0	3.0
36684.W0660	M 6	60	4.2	11.0	6.5	3.00	8.0	3.0
36684.W0820	M 8	20	6.0	15.0	8.5	4.10	10.0	4.0



Coatings and Drive Types

Wixroyd produce a wide range of fasteners designed for application where it is important that fasteners are not separated from equipment (e.g. cover panels etc). This is now important to ensure that equipment complies with Machinery Directive 200642/EC - requiring that fasteners remain attached to fixed guards or equipment when guards are removed.





Our captive panel screws are manufactured mainly from stainless steel (AISI 303, 1.4305 grade), but they can also be produced in stainless steel (A4, AISI 316), aluminium, brass or zinc plated steel.

Many finishes can be applied - black oxide finish, anodizing etc.

The main options are as follows:

Finish	Notes
Black Chrome (MIL-C-1458B)	Black chrome is a hard, non-reflective coating which is resistant to abrasion, heat and corrosion. The black chrome surface is a dull, dark grey and may be waxed or oiled to darken surface.
Black Oxide Coating (MIL-C-13924B)	Black oxide is a uniform black coating for ferrous metals. Generally it is considered a decorative coating and provides only very limited corrosion protection under mild corrosion conditions.
Cadmium	Cadmium is a bright, silvery white plating. Supplementary treatments for Type II can be golden, iridescent, amber, black or olive drab.
Passivate (QQ-P-35/MIL S-500SC)	Passivation is a process designed to remove foreign metals from the surface of stainless and corrosion resistant steels.
Phosphate Coating Light (TT-C-00490B)	Phosphate coating is a light coating for use as a base paint.
Gold (MIL-G-45204B)	Yellow to orange colour depending on proprietary process used. Will range from matt to bright finish depending on base metal. Good corrosion resistance and high tarnish resistance.
Nickel (QQ-N-290A)	Nickel is a corrosion protective plating for steel, zinc and zinc alloys as well as copper and copper alloys.
Zinc (QQ-Z-325C)	The primary use of chromate finishes on zinc is to retard or prevent formation of white corrosion products on zinc surfaces.

Coatings

Schematic	Drive Types	Uses
	Hexagonal	Ideal for precision assembly. Most recommended where less surface area is available.
	Crosshead (Phillips®)	Provides good control in driving. Always use a driver bit of the proper size which is in good condition.
	Hexalobular (Torx®)	Positive-engaging, fast-locating method which transmits drive torque with less required downward pressure. Good fastening appearance.
	Slotted	Accepts standard blade screwdriver. Requires less downward pressure to drive parts than those with recessed openings. Use a proper fitting blade to minimize slippage.
	Security	These screws are impossible to remove without the special matching screw driver.

Drive Types



36681 - Cap head - hex. socket



36682 - Cap head - hex. socket Security and Torx® options

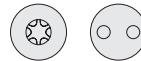

36683 - Pan Head - Phillips® Security and Torx® options

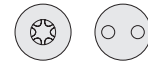

36684 - Countersunk - hex. socket Security and Torx® options

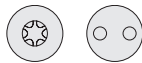

36686 - Thin head thumb screw



36687 - Thumb screw



36691 - Threaded captive washers

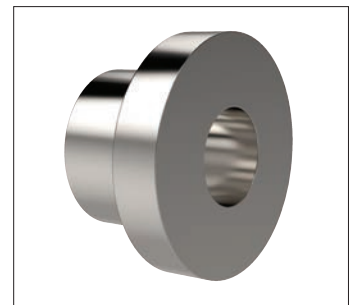

36692 - Retainer flanges



One option to retain screws to panels are our retaining washers. Used in place of retainer flanges, retaining washers are simple but effective when used with our captive screws. The captive screws have a normal thread then a reduced diameter for the rest of the screw length.

The retaining washer has a small length of thread on the internal diameter and once screwed on to the captive screw is effectively captive.

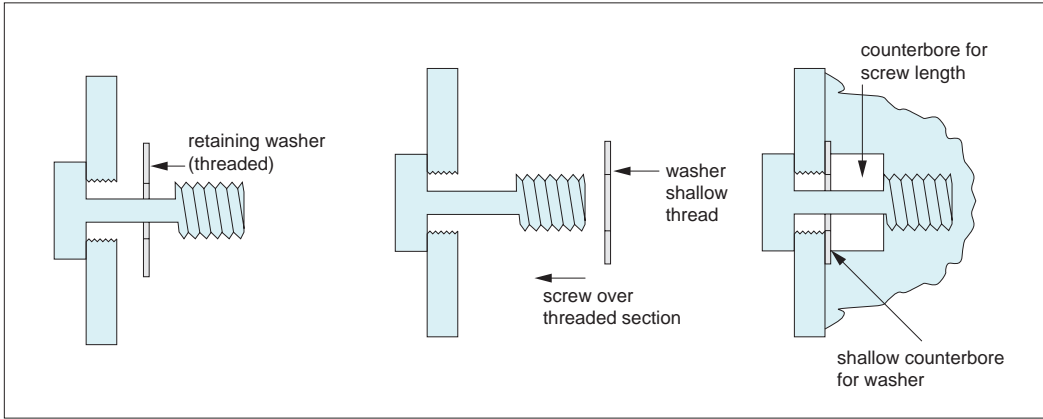

Example

Screw the thin retaining washer onto the captive screw and the screw is therefore retained to the panel.

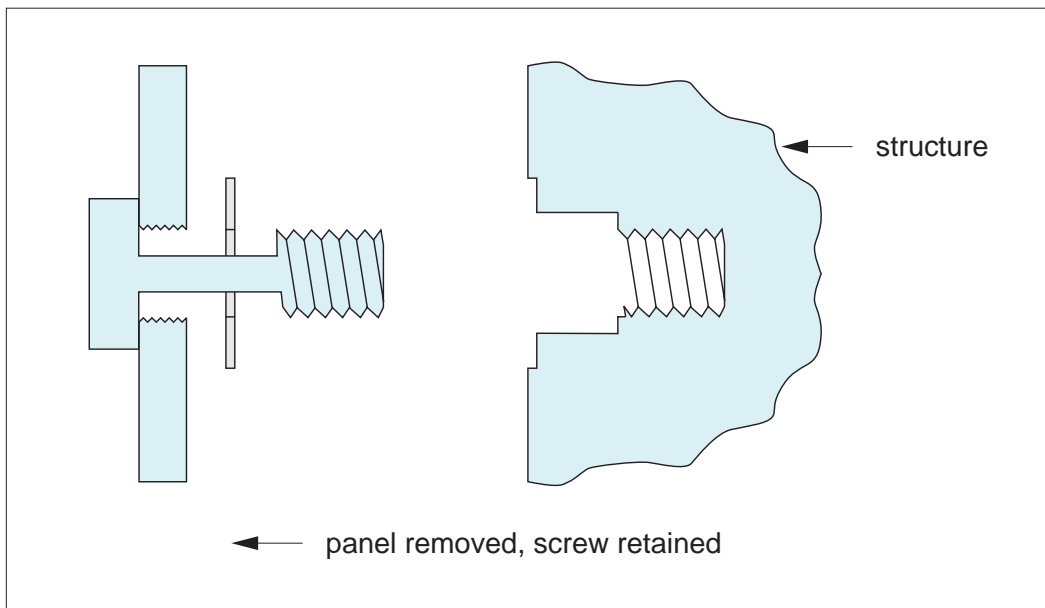

CAPTIVE SCREWS

ov-W36681-AP0152.A2-T-W36692-AP0169.A2-T-retaining-washers-c-rmh - Updated - 28-10-2022