

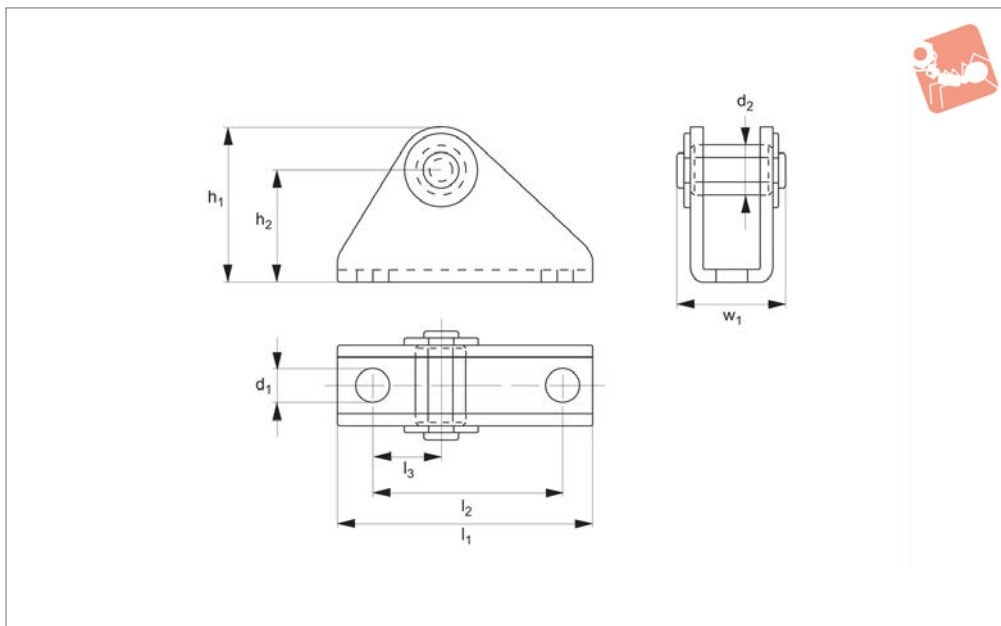

Fixed Catch - Narrow

for part no. 41781.W0003



41791.1

STEEL TOGGLE CLAMPS

Material

Body: steel, zinc plated.
Rivets: stainless steel running in hardened

bushes.

Technical Notes

The adjustment range of the clamp can be

altered by rotating the fixed catch.
Use socket cap screws for mounting.

Order No.	Size	h_1	d_1	d_2	h_2	l_1	l_2	l_3	w_1	Weight g
41791.W0013	3	32	6.5	10	23	52	38	14	22	65



Welding Fixtures

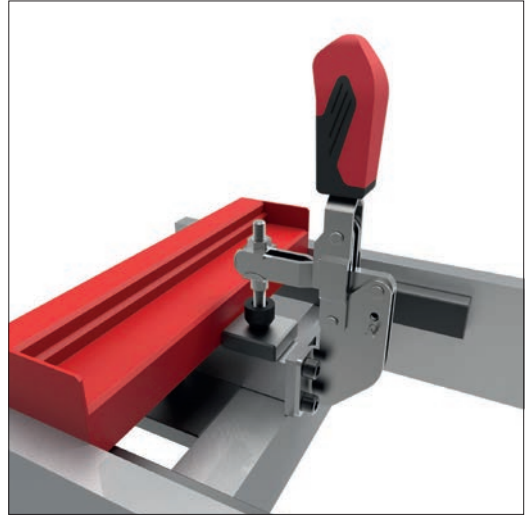
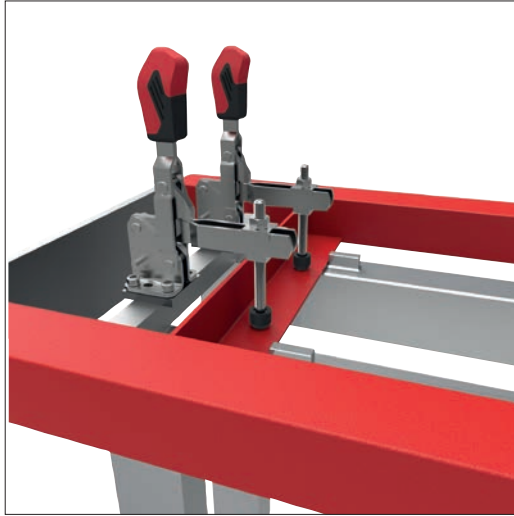

Machining and Jig Assemblies

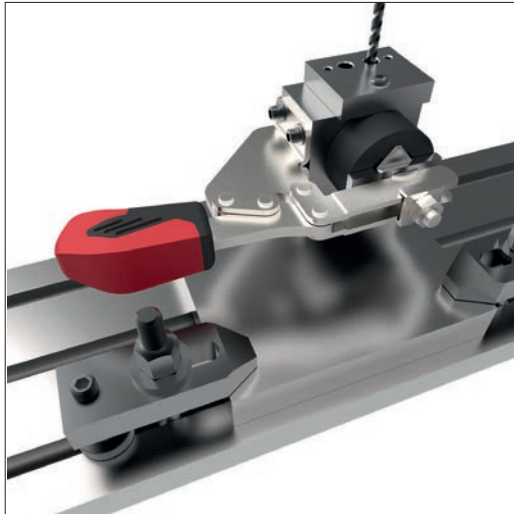

Cmm's

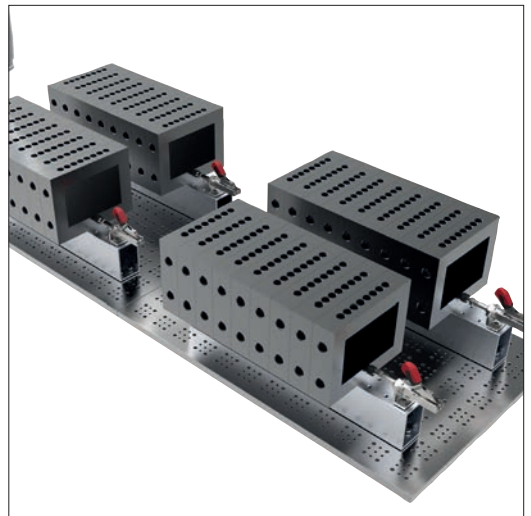
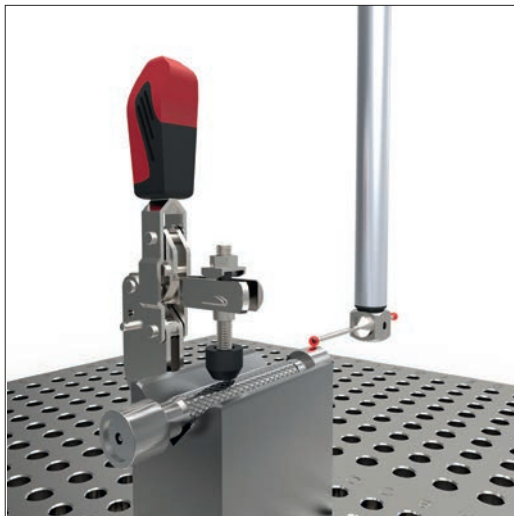



STEEL TOGGLE CLAMPS

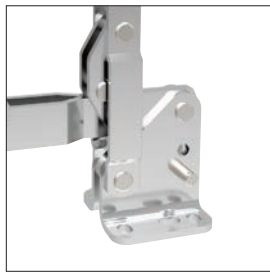

Horizontal base

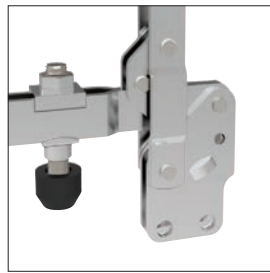

Vertical base

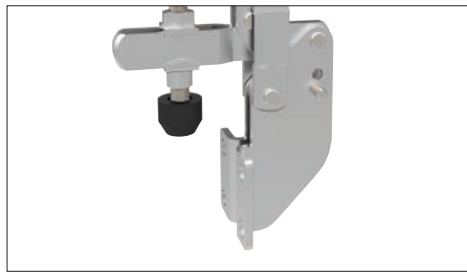

Angled base

Mounting Base Variations



Vertical acting



Horizontal acting



Push-pull

Clamping Variations



Hook type



Latch type

Explanation of forces

The force transmitted to the workpiece by the toggle clamp's closed arm, without itself being deformed when machine forces are applied. The holding force value is dependent upon the proximity of the measuring load point to the toggle clamp's pivot point (therefore two values, F_1 and F_2 are provided).

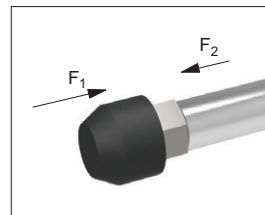
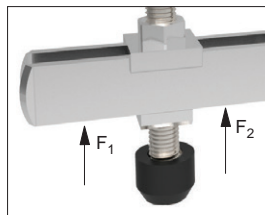

Holding Forces F_1 or F_2

The force applied to the workpiece when the toggle clamp's arm is closed. These clamping forces can only be stated for pneumatic toggle clamps, clamping forces of manual clamps cannot be easily measured as they are dependent upon the operator.

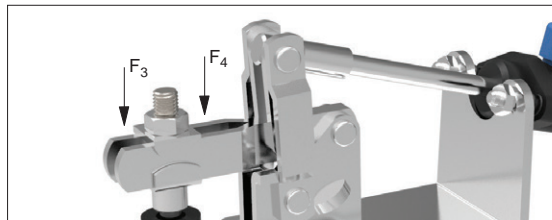

Clamping Forces F_3 or F_4

For pneumatically controlled toggle clamps only, F_5 is the piston force required (at 6 bar to) achieve the stated clamping force.

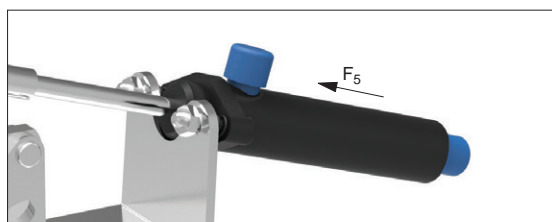

Piston Forces F_5

ov-W40000.1-A-T-W42070-A-T-b-rmh- Updated -27-10-2022



Quality Features



Ergonomic soft grip
2-component handle



Stainless rivets and
hardened bushings



Moveable stop for
variable opening angle

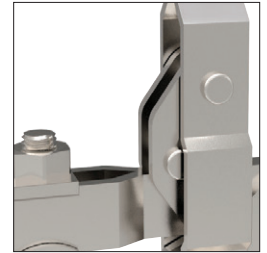

Operator
finger protection

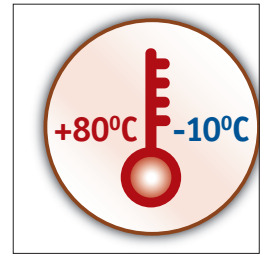

Temperature resistant

Unique Features



Safety catches



Heavy duty versions



Pneumatic versions



Matt black surface for
optical measurement

Materials



Steel, zinc plated
and passivated



Stainless steel (304)



Steel, matt black
vario-spektron coated



Protective cap and
handle made of an
electrostatic conductive
(dissipative) material.