

65990

ROD ENDS

Material

Body: surface zinc plated
 Race: steel/ bronze - PTFE composite.
 Inner ring: bearing steel, hardened ground and spherical surface chromium plates.
 Outer ring: brass body pressed around,

outer race lined with bronze - PTFE composite.

Technical Notes

Maintenance free. Sizes according to DIN ISO 12240-4 series K.

Tips

Standard thread is right hand thread.
 Rod end studs are all right hand threads.

Important Notes

*Denotes fine pitch threads.

Order No.	Thread hand	d ₁	d ₂	l ₁	w ₁	d ₃	d ₄	d ₅	d ₆	l ₂	Weight g
65990.W0106	Right	M6	M6	30	9	20	10.0	13	9.0	12	22
65990.W0108	Right	M8	M8	36	12	24	12.5	16	10.5	16	47
65990.W0110	Right	M10	M10	43	14	28	15.0	19	13.0	20	77
65990.W0111	Right	M10 x 1,25*	M10	43	14	28	15.0	19	13.0	20	77
65990.W0112	Right	M12	M12	50	16	32	17.5	22	15.0	22	100
65990.W0113	Right	M12 x 1,25*	M12	50	16	32	17.5	22	15.0	22	100
65990.W0114	Right	M14	M14	57	19	36	20.0	25	17.0	25	160
65990.W0115	Right	M14 x 1,5*	M14	57	19	36	20.0	25	17.0	25	160
65990.W0116	Right	M16	M16	64	21	42	22.0	27	19.0	28	220
65990.W0117	Right	M16 x 1,5*	M16	64	21	42	22.0	27	19.0	28	220
65990.W0506	Left	M6	M6	30	9	20	10.0	13	9.0	12	22
65990.W0508	Left	M8	M8	36	12	24	12.5	16	10.5	16	47
65990.W0510	Left	M10	M10	43	14	28	15.0	19	13.0	20	77
65990.W0511	Left	M10 x 1,25*	M10	43	14	28	15.0	19	13.0	20	77
65990.W0512	Left	M12	M12	50	16	32	17.5	22	15.0	22	100
65990.W0513	Left	M12 x 1,25*	M12	50	16	32	17.5	22	15.0	22	100
65990.W0514	Left	M14	M14	57	19	36	20.0	25	17.0	25	160
65990.W0515	Left	M14 x 1,50*	M14	57	19	36	20.0	25	17.0	25	160
65990.W0516	Left	M16	M16	64	21	42	22.0	27	19.0	28	220
65990.W0517	Left	M16 x 1,50*	M16	64	21	42	22.0	27	19.0	28	220

Order No.	l ₃	l ₄	l ₅	w ₂	A/F ₁	A/F ₂	a°	Static load C ₀ kN max.
65990.W0106	18.5	13	10	6.75	11	8	13	7.7
65990.W0108	23.5	17	13	9.00	14	8	14	12.9
65990.W0110	28.0	21	17	10.50	17	12	13	18.0
65990.W0111	28.0	21	17	10.50	17	12	13	18.0
65990.W0112	32.5	25	20	12.00	19	14	13	24.0
65990.W0113	32.5	25	20	12.00	19	14	13	24.0
65990.W0114	37.5	29	22	13.50	22	14	16	31.0
65990.W0115	37.5	29	22	13.50	22	14	16	31.0

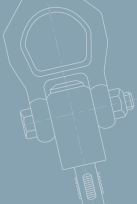

Order No.	l_3	l_4	l_5	w_2	A/F_1	A/F_2	α °	Static load C_0 kN max.
65990.W0116	42.5	33	24	15.00	22	17	15	39.0
65990.W0117	42.5	33	24	15.00	22	17	15	39.0
65990.W0506	18.5	13	10	6.75	11	8	13	7.7
65990.W0508	23.5	17	13	9.00	14	8	14	12.9
65990.W0510	28.0	21	17	10.50	17	12	13	18.0
65990.W0511	28.0	21	17	10.50	17	12	13	18.0
65990.W0512	32.5	25	20	12.00	19	14	13	24.0
65990.W0513	32.5	25	20	12.00	19	14	13	24.0
65990.W0514	37.5	29	22	13.50	22	14	16	31.0
65990.W0515	37.5	29	22	13.50	22	14	16	31.0
65990.W0516	42.5	33	24	15.00	22	17	15	39.0
65990.W0517	42.5	33	24	15.00	22	17	15	39.0



All of our rod ends incorporate either a plain spherical bearing, ball bearing, or roller bearing. Below is an overview of each type.

Plain spherical bearings

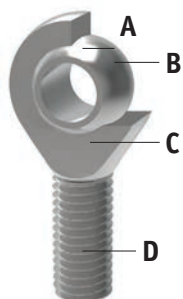

- A** Made from Polyamid-PTFE-fibreglass-compound, maintenance free, absorbs any foreign particles
- B** Ball made of bearing steel, hardened, ground, polished and hard chromium plated, ensures reliable corrosion protection
- C** No clearance - radial clearance 0-10µm
- D** All rod ends housings made of forged steel, tempered, extremely high loads resistant

Ball and roller bearings

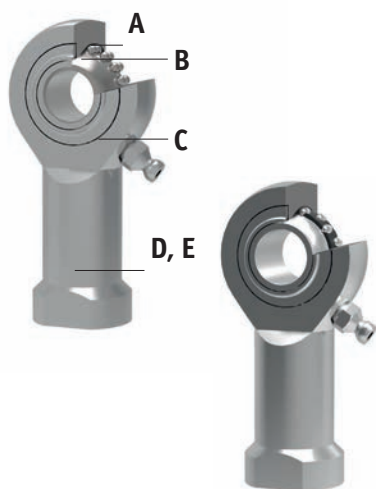

- A** Radial clearance: 10-30µm, low friction
- B** Inner ring made of bearing steel, hardened ball grooves polished
- C** Shields on both sides protect against rough dirt penetration
- D** All rod ends housings are made of forged steel, case hardened bearing race
- E** Low maintenance due to long-term greasing, especially suitable for high speed large swiveling angles or rotating movements

Rod ends and water



Stainless steel versions

Most of our rod ends are available in stainless steel as standard

High grade AISI 316 stainless steel available on request

Rod Ends from Automation Components

ROD ENDS

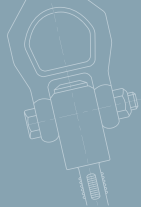

Rod ends with integral maintenance-free spherical plain bearings

In many cases heavy-duty rod ends with integral spherical plain bearings are most often used. They are above all used for small swivelling or tilting movements at low speeds. They stand out for their high load capacity and can also be used for shock-like loads. The rod end ball slides on a plastic bearing shell consisting of a glass fibre-filled nylon/teflon compound. This design assures a maintenance-free rod end. Heavy-duty plain bearing rod ends have slight initial movement friction and virtually no clearance. The plastic material used has another advantage in that it can absorb many foreign particles so that no damage can occur. The balls of heavy-duty rod ends with integral spherical plain bearings are hard chrome plated. This reliable corrosion protection ensures that the function of the rod end will not be affected by a corroded ball surface under humid operating conditions.

Rod ends with integral ball bearings

This design is especially suitable for high speeds, large swivelling angles or rotating movements with relatively low or medium loads. Prominent technical features are the low bearing friction, long-time greasing as well as the sealing against some dirt penetration (by means of shields on both sides). Under normal operating conditions the rod ends are maintenance-free.

Greasing nipples are provided for lubrication in case of rough operations and maximum loads. To avoid incompatibility with the production lubrication, we recommend lubrication with a calcium-complex-soap-grease. A special heat treatment procedure gives the rod end housing a raceway hardness adapted to the antifriction bearing, ensuring at the same time high stability with changing loads.

Rod ends with integral roller bearings

This design based on the structure of a self-aligning roller bearing is preferably used for high speed, large tilting angles or rotating movements under high loads. Compared to rod ends with ball bearings, rod ends with self-aligning roller bearings have essentially higher basic load ratings. This design is equipped with a cage to minimise the rolling friction and heat build-up. These rod ends, with long-time lubrication are under normal operating conditions maintenance-free.

Greasing nipples are provided for lubrication in case of rough operations and maximum loads. To avoid incompatibility with the production lubrication, we recommend lubricating with a calcium-complex-soap-grease.

Shields on both sides limit dirt particles from penetrating into the bearing. The rod ends with roller bearings are, subjected to a special heat treatment to obtain a raceway hardness adapted to the antifriction bearings, ensuring at the same time a high stability with changing loads.



Static load capacity C_0 (plain bearings)

The static load capacity C_0 is the radially acting static load which does not cause any permanent deformation of the components when the spherical bearing or rod end is stationary, (i.e. the load condition without pivoting, swivelling or tilting movements).

It is also a precondition here that the operating temperature must be at normal room temperature and the surrounding components must possess sufficient stability.

The values specified in the tables are determined by static tension tests on a representative number of series components at 20°C normal room temperature. The static load capacity may vary with lower or higher temperature depending on the material.

In the case of all rod ends with plain bearings, the static load rating refers to the maximum permissible static load of the rod end housing in a tensile direction up to which no permanent deformation occurs at the weakest housing cross-section. The value in the product tables has a safety factor of 1.2 times the tensile strength of the rod ends housing material.

Static load capacity C_0 (roller and ball bearings)

For our rod ends with roller and ball bearings, the static load rating is the load at which the bearing can operate at room temperature without its performance being impaired as a result of deformations, fracture, or damage to the sliding contact surfaces (max 1/10,000th of the ball diameter).

Dynamic load capacity C (plain bearings)

Dynamic load ratings serve as values for calculation of the service life of dynamically-loaded spherical bearings and rod ends. The values themselves do not provide any information about the effective dynamic load capacity of the spherical bearing or rod end. To obtain this information, it is necessary to take into account the additional influencing factors such as load type, swivel or tilt angle, speed characteristic, max. permitted bearing clearance, max. permitted bearing friction, lubrication conditions and temperature, etc.

Dynamic load capacities depend on the definition used to calculate them. Comparison of values is not always possible owing to the different definitions used by various manufacturers, and because the load capacities are often determined under completely different test conditions.

Dynamic load capacity C (roller and ball bearings)

For our rod ends with roller and ball bearings, the dynamic load capacity is the load at which 90% of a large quantity of identical rod ends reach 1 million revolutions before they fail (due to fatigue of the rolling surfaces).

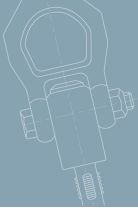

Low cost rod ends load ratings

The ultimate radial static load rating is measured as the failure point when a load is increasingly applied to a pin through the rod end's bore and pulled straight up while the rod end is held in place. Note that the actual rating is determined by calculating the lowest of the following three values:

1: Raceway material comprehensive strength (R value):

$$R = E \times T \times X$$

2: Rod end head strength (H value, cartridge type construction):

$$H = \left[\left(\frac{T}{2} \sqrt{D^2 - T^2} \right) + \left(\frac{D^2}{2} \times \text{SIN}^{-1} \frac{T}{2} \right) - (\text{O.D. of Bearing} \times T) \right] \times X$$

Angle of $\frac{T}{2}$ expressed in radians

3: Shank strength (S Value) male threaded rod end:

$$S = [(\text{root diameter of thread}^2 \times .78) - (N^2 \times .78)] \times X$$

female threaded rod end:

$$S_2 = [(J^2 \times .78) + (\text{major diameter of thread} \times .78)] \times X$$

- Where: E = Ball diameter
 T = Housing width
 X = Allowable stress
 D = Head diameter
 N = Diameter of drilled hole in shank of male rod end
 J = Shank diameter of female rod end

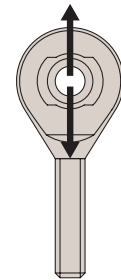

The axial static load capacity is measured as the force required to cause failure via a load parallel to the axis of the bore. Depending on the material types and construction methods, the ultimate axial load is generally 10-20% of the ultimate radial static load. The formula does not account for the bending of the shank due to a moment of force, nor the strength of the stake in cartridge-type construction.

Axial strength (A Value):

$$A = .78 [(E + .176T)^2 - E^2] \times X$$

- Where: X = Allowable stress (see table below)
 E = Ball diameter
 T = Housing width

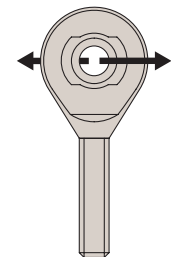

Material	Allowable stress (PSI)
300 Series Stainless Steel	35,000
Low Carbon Steel	52,000

Rod Ends from Automation Components

ROD ENDS