

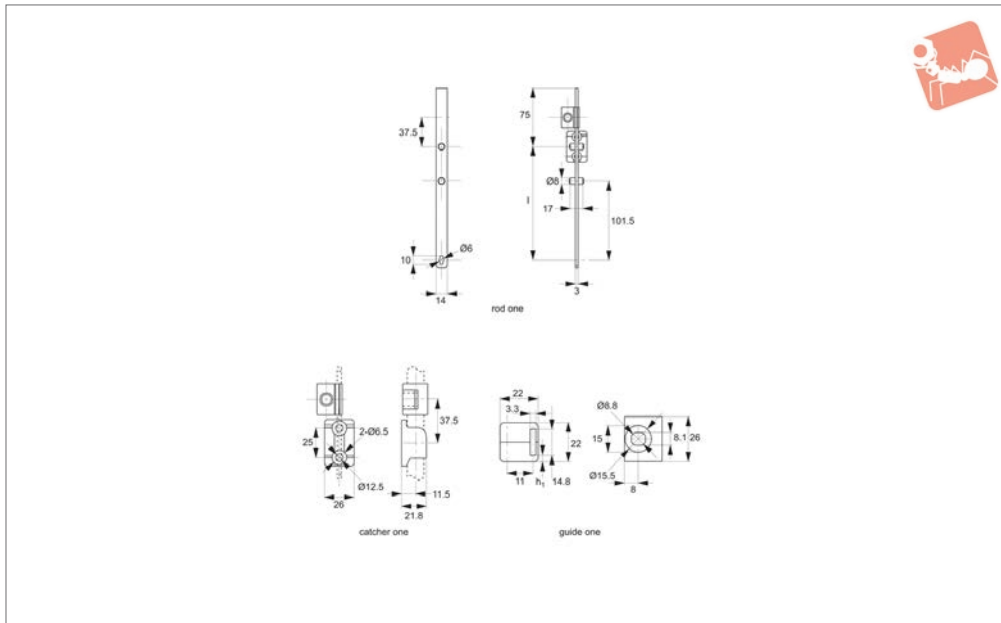

Multi-Point Latching Set

flat rod with locking pins - for cam latches and

Cam Latch Accessories



A0325

CAM LATCH ACCESSORIES

Material

Rod: steel, zinc plated.
 Rod Guides One: polyamide, PA6.
 Rod Catcher: die cast zinc, black.

Technical Notes

For use with cam latches & locks, making a

full 3-point latching system. Distance between base of rod and inside of door depends upon height of rod guide selected, see dimension h_1 .

Rod guides: fixed via counter sunk screw or weld-on stud.

Cams: see two point cams A0240 to achieve 3-point locking.

Important Notes

Please order rods, rod guides and rod catcher separately.

| Order No. | Type | Length l | h_1 |
|--------------|-------------|----------|-------|
| A0325.AW1070 | Rod One | 760 | - |
| A0325.AW0800 | Rod Guide | - | 3.6 |
| A0325.AW0900 | Rod Catcher | - | - |

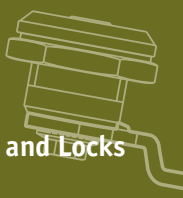

Applications outside the gasket

OUTSIDE GASKET

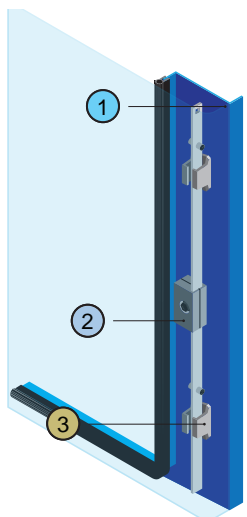



① Multi-Point latching rod **A0325.AW1070**

② Flat rod guide **A0321.AW0800**

③ Rod catcher **A0325.AW0900**

CAM LATCH ACCESSORIES

Round rod and accessories compatibility

| Round rod type | Part no. A0325 compatible with: | Rod one .AW01xx |
|--------------------------------|---|-----------------|
| Two point cam (A0240) | | ✓ |
| Integrated rod control systems | | ✓ |
| Required accessories: | | |
| Rod guide A0325.AW0800 |  | ✓ |
| Rod catcher A0325.AW0900 |  | ✓ |

Note: Use of rod guide is essential for all applications.

Ordering example for complete rod set

To suit a single enclosure door, where h1 (height between base of rod and inside of door) = 3,6mm.
 1 x A0325.AW1070 - flat rod (pkt of 2).
 1 x A0325.AW0800 - rod guide (pkt of 2), h1 = 3,6mm.
 1 x A0325.AW0900 - rod catcher (pkt of 2).



Many industrial cabinets are made of low gauge sheet metal. These often flex under their own weight and can be forced outward due to pressure from the cabinet's internal environment (i.e. air pressure). While a gasket or seal will improve performance, all round consistent sealing is often not achieved because only a single point locking latch is used - to achieve optimum all round sealing a multi-point latching system is required.

What is multi-point latching

For larger cabinets the use of Wixroyd rods and rod guides provide a multi-point latching system locking at two, three or more points on the cabinet - often these points are at the top, bottom and middle of the cabinet.

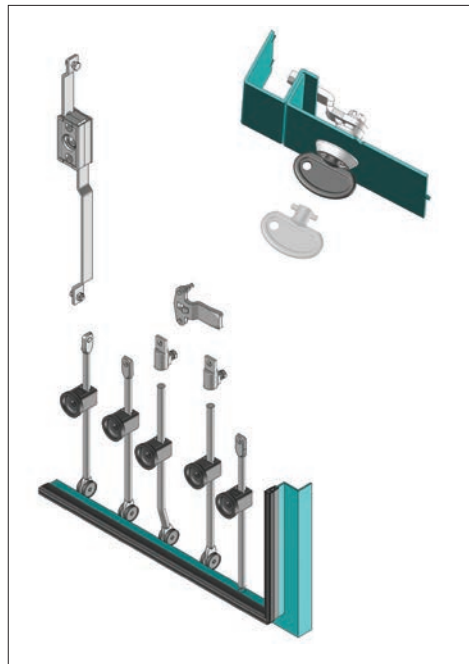

With each multi-point latching system there will be an actuating cam latch, lock or swing handle - attached to these, inside of the cabinet, are a cam and two latching rods.

When the latch is actuated to close, the cam engages with the door frame to provide the first point of locking, while at the same time one of the latching rods moves upwards, while the other down and engages with the top and bottom of the cabinet frame respectively, to provide the second and third points of locking.

Multi-point latching systems can be installed both inside and outside of the cabinet gasket.

Wixroyd multi-point latching systems provide flexible options for locking at several points of a cabinet; increasing security, improving environmental control within a cabinet, and greater stability of tall cabinets.

How does multi-point latching work?



1. In conjunction with a standard cam latch, lock or swing handle, use a multi-point cam (A0240) and a latching rod set (A0303, A0321, A0325) to achieve three points of locking.



2. In conjunction with a standard cam latch, lock or swing handle, use a two point locking adaptor A0243 and a latching rod set (A0303, A0321, A0325) to achieve two points of locking.

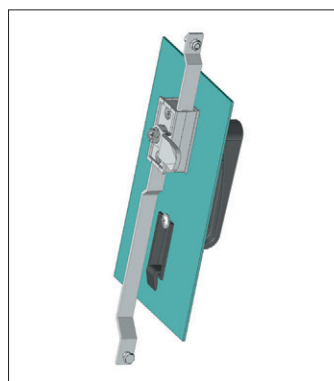

3. We have a range of swing handles and flush T-handle cam latches with integrated rod control systems. These integrated systems make attachment of latching rod sets far simpler and far more robust. Together they achieve three points of locking.

Different approaches to multi-point latching



Example of Rod Latch Application

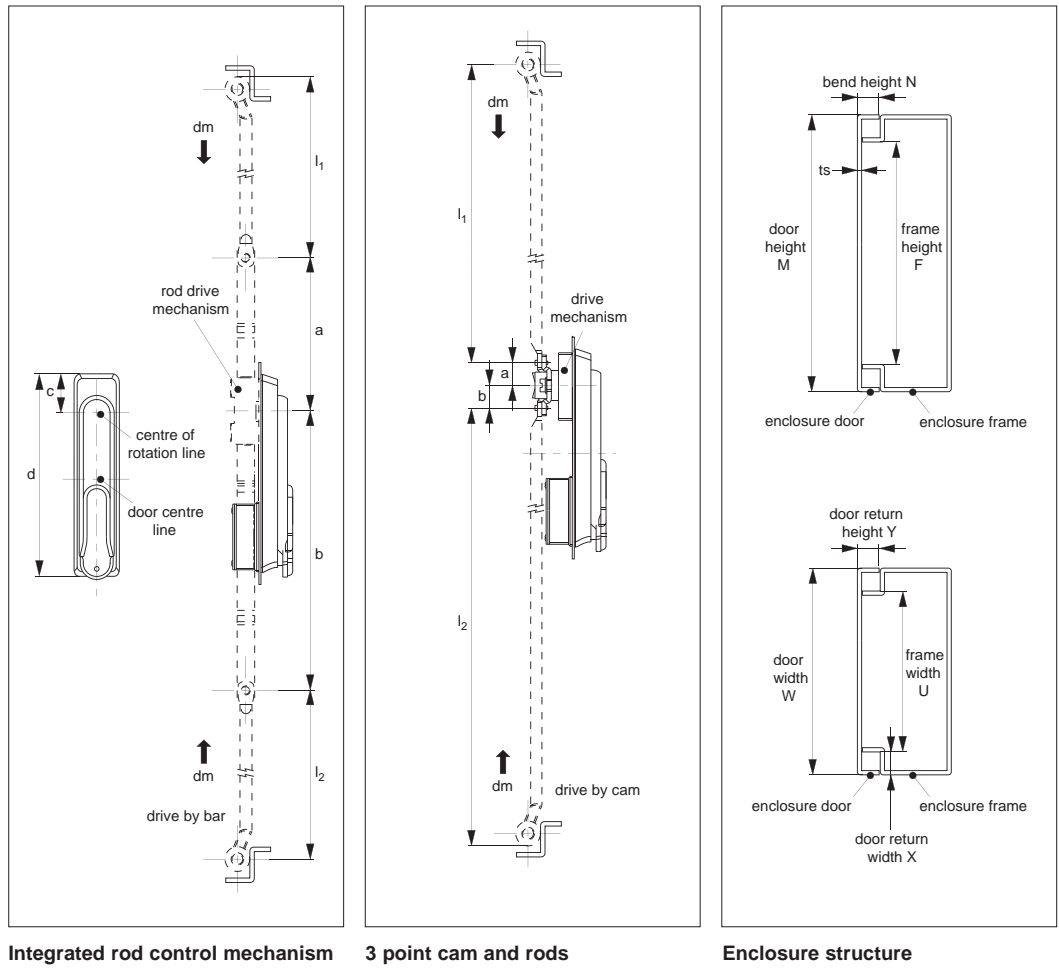

Calculate the length of the rod

d_m = rod stroke
(distance rod moves when latch is actuated)
 f = door frame height

Calculation of rod lengths from centreline of rotation:

$$l_1 = \frac{f}{2} - a + (d_m - 2)$$

$$l_2 = \frac{f}{2} - b + (d_m - 2)$$

Calculation of rod lengths from centerline of door used:

$$l_1 = \frac{f}{2} - [a + (\frac{d}{2 - c})] + (d_m - 2)$$

$$l_2 = \frac{f}{2} - [b + (\frac{d}{2 - c})] + (d_m - 2)$$

Important Note: The effective length of a connecting piece should be deducted if used. This calculation method is applicable for those rods mounted inside gaskets.