

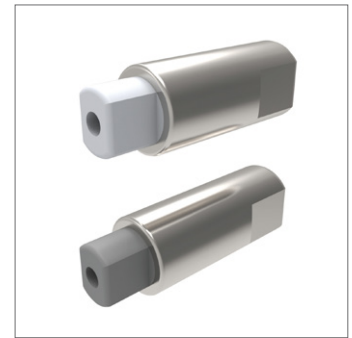

Torque Dampers

uni-directional - 125° operating angle

Torque Dampers

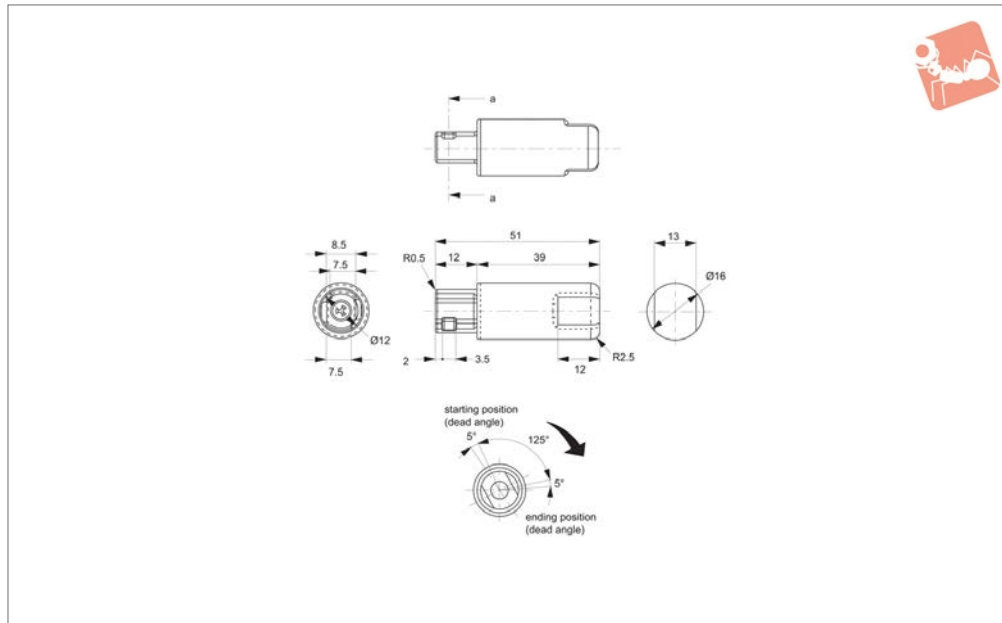

Q0430

TORQUE DAMPERS

Material

Body: stainless steel, AISI 304.
 Shaft: PBT plastic. White for anti-clockwise version, grey for clockwise version. Different torque forces marked by colour coded dot on shaft.

Technical Notes

125° operating angle, additional 5° dead

angle at start/end position.
 Tested to over 100,000 cycles.
 Temperature range 0° to 40°C.

Tips

Provide smooth and quiet motion of lids, covers etc. Ideal for special purpose machines, air conditioning units etc.

Important Notes

Torque calculation:

$T \text{ (Kgf.cm)} = W \text{ (Kg)} \times 0.5 \times H \text{ (cm)}$.
 W (Kg) is weight of cover/lid, H (cm) is distance between fulcrum and cover/lid's opening edge.

Order No.	Type	Shaft colour	Operating angle	Torque colour marking	Damping torque kgf/cm	Weight g
Q0430.AC0010	Anti-Clockwise	White	125°	Blue	20,4 - 26,5	20
Q0430.AC0020	Anti-Clockwise	White	125°	Red	24,5 - 30,6	20
Q0430.AC0110	Clockwise	Grey	125°	Blue	20,4 - 26,5	20
Q0430.AC0120	Clockwise	Grey	125°	Red	24,5 - 30,6	20

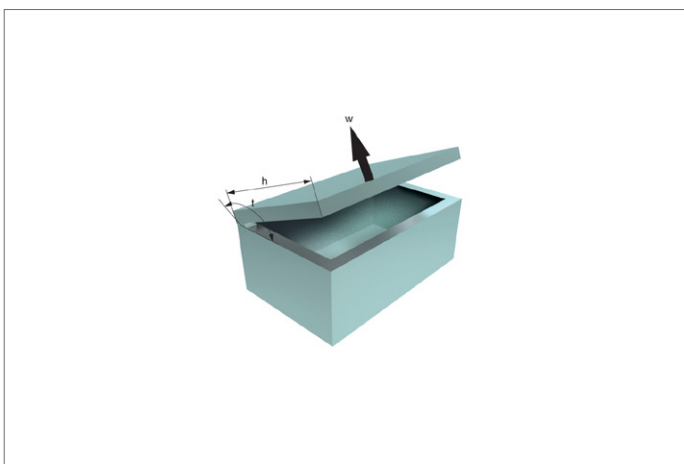



Wixroyd torque dampers offer controlled opening and closing of lids, drawers, covers and much more, they provide a wide range of solutions for a variety of applications creating smooth movement and function.

Though unnoticed in many applications, torque dampers are a vital part of many products bringing quality, safety and durability. Torque dampers provide quality movement enhancing both touch and feel.

Operating principle

Torque dampers utilise the movement of fluid forced from one chamber to another via a rotor. Dampening speed is dependent upon the viscosity of the fluid and the diameter of the fluid aperture.

Torque calculation

To calculate the torque for your application, the following measurements are necessary.

$$t \text{ (torque)} = w \times 0.5 \times h$$

h = length from pivot point to end of lid (cm)

w = weight of the lid (Kg)

Torque force stated per product (see individual product pages), is the maximum torque to which the specified part can be exposed before the dampening force yields and hence dampening is overcome.

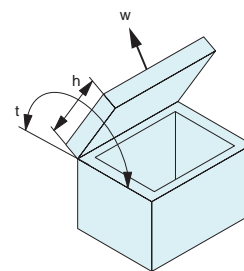

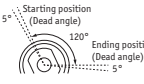

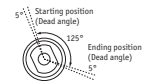

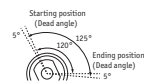

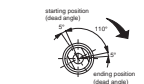

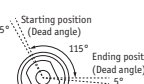

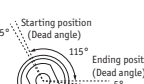

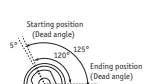

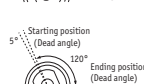

Table of torque dampers: Torque ranges

Part no.	Torque damper range	Torque Kgf.cm	Torque Kgf.cm																
			10	20	30	40	50	60	70	80	90	100	110	120	130	140	150		
 Q0400		15 - 35		█	█														
 Q0420		10 - 25		█	█														
 Q0422		10 - 35		█	█														
 Q0430		20 - 30			█	█													
 Q0440		8 - 25		█	█														
 Q0460		10 - 18		█	█														
 Q0462		10 - 30		█	█														
 Q1000		30 - 70				█	█	█	█										
 Q1002		60 - 140								█	█	█	█	█	█				
 Q1010		30 - 50				█	█												
 Q1050		20 - 50				█	█												
 Q1060		61 - 81										█	█						