

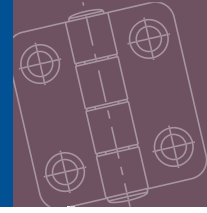

Surface Mount - Leaf Hinges

screw mount - stainless steel



Hinges

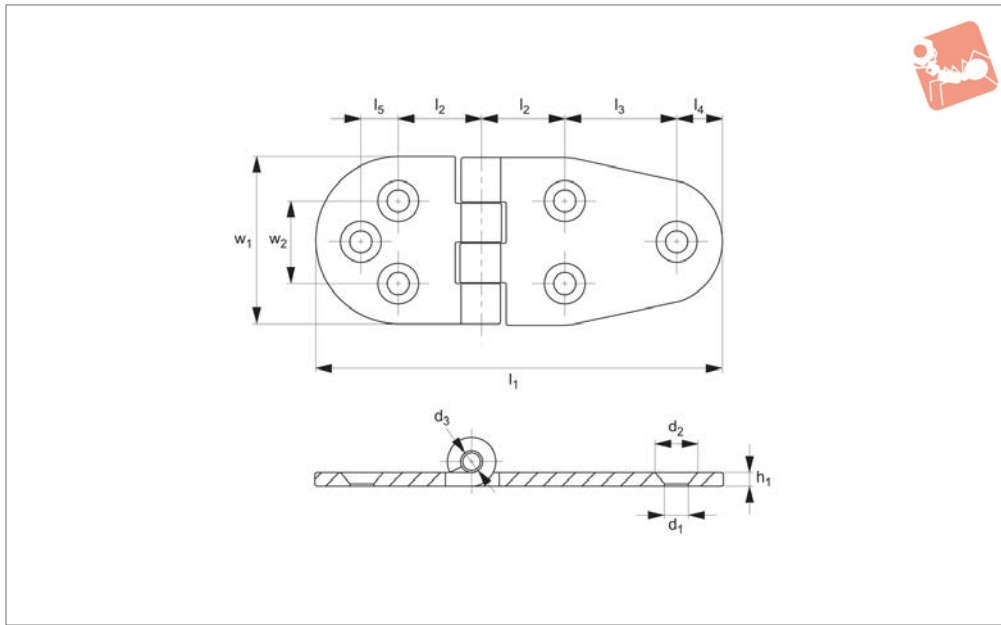

S0462

HINGES

Material

Hinge: stainless steel.

Technical Notes

Opening angle 180°.

Order No.	h_1	l_1	l_2	l_3	l_4	l_5	w_1	w_2	F_x N	F_y N	d_1	d_2	d_3
S0462.AW0040	2.5	99.5	20	27	12.7	9	40	20	520	600	5.6	10	5



Concealed hinges

For added security or a sleek enclosure design, concealed hinges offer the solution with mounting discreetly hidden away from view to avoid tampering.

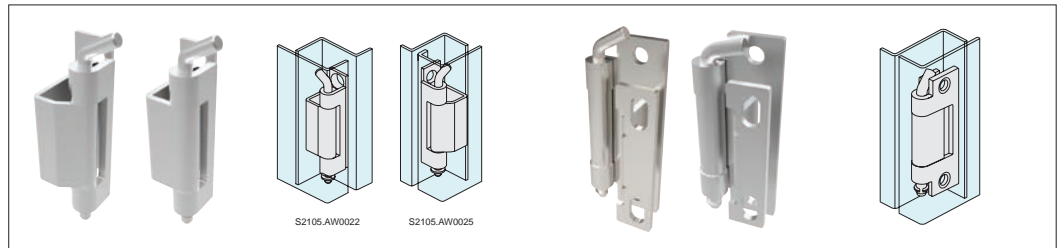

Concealed pivot hinges

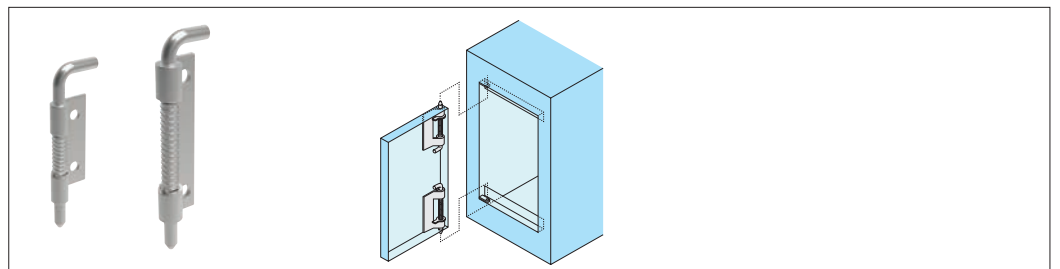

End mount concealed pivot hinges

Door removal hinges

Door removal or lift-off hinges simplify removal of covers and panels to ease access for maintenance and repair, available in a selection of materials.

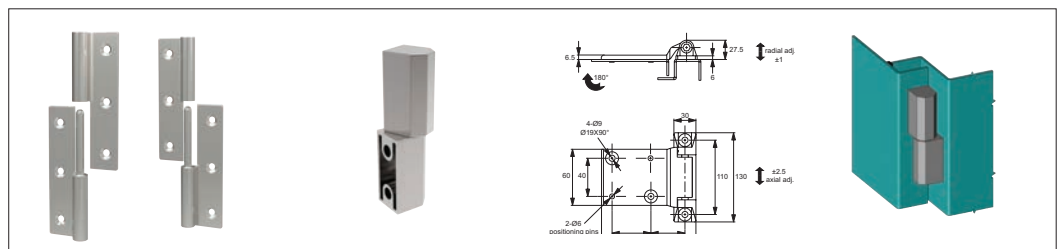

Lift off hinges

Torque and positioning hinges

Torque and positioning hinges offer positive location of panels, screens and displays using constant friction for a firm hold.



Constant torque hinges

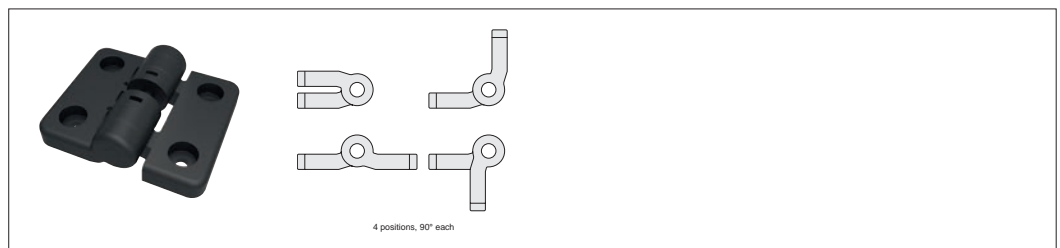

Detent positioning hinges

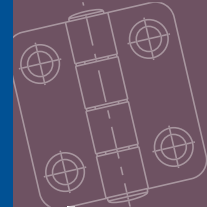

For added security or a sleek enclosure design, concealed hinges offer the solution with mounting discreetly hidden away from view to avoid tampering.

Concealed hinges

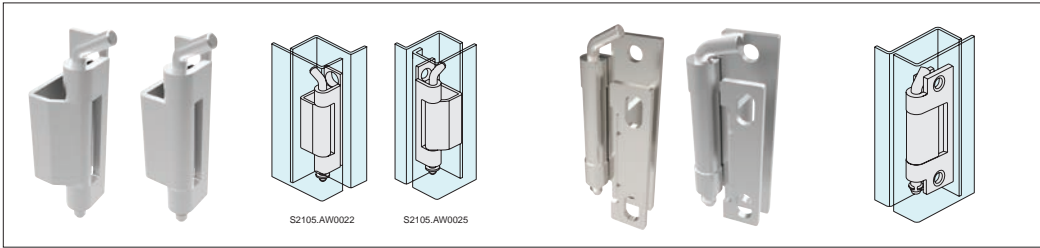

Concealed pivot hinges

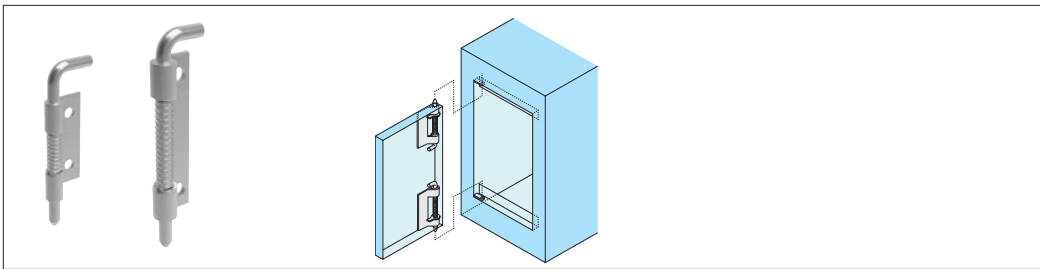

End mount concealed pivot hinges

Door removal or lift-off hinges simplify removal of covers and panels to ease access for maintenance and repair, available in a selection of materials.

Door removal hinges

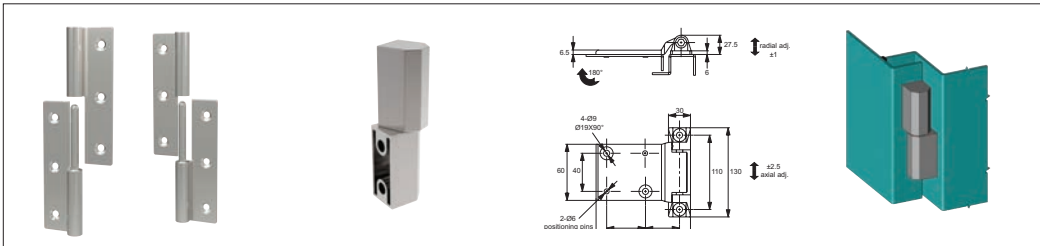

Lift off hinges

Torque and positioning hinges offer positive location of panels, screens and displays using constant friction for a firm hold.

Torque and positioning hinges



Constant torque hinges

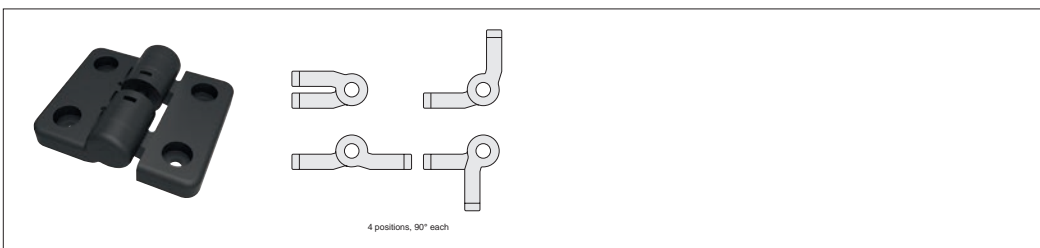

Detent positioning hinges

HINGES

ov-W50050-A-T-W51828-A-T-wide-range-of-solutions-rmh - Updated - 01-11-2022