

Z0550

Material

EPDM, black.

Larger lengths in multiples of 10m are available on request.

Information in the plastics and rubbers table in our technical index.

Technical Notes

Supplied in 10m lengths as standard.

Tips

For properties of EPDM material see information in the plastics and rubbers table in our technical index.

Order No.	Material	Colour	Grip range mm	Standard length m
Z0550.AW0001	EPDM	Black	1,0-2,0	10
Z0550.AW0002	EPDM	Black	1,0-2,0	10
Z0550.AW0003	EPDM	Black	1,0-2,0	10
Z0550.AW0004	EPDM	Black	1,0-1,5	10
Z0550.AW0005	EPDM	Black	1,0-1,5	10

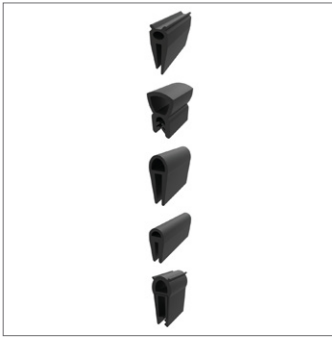

Z0552

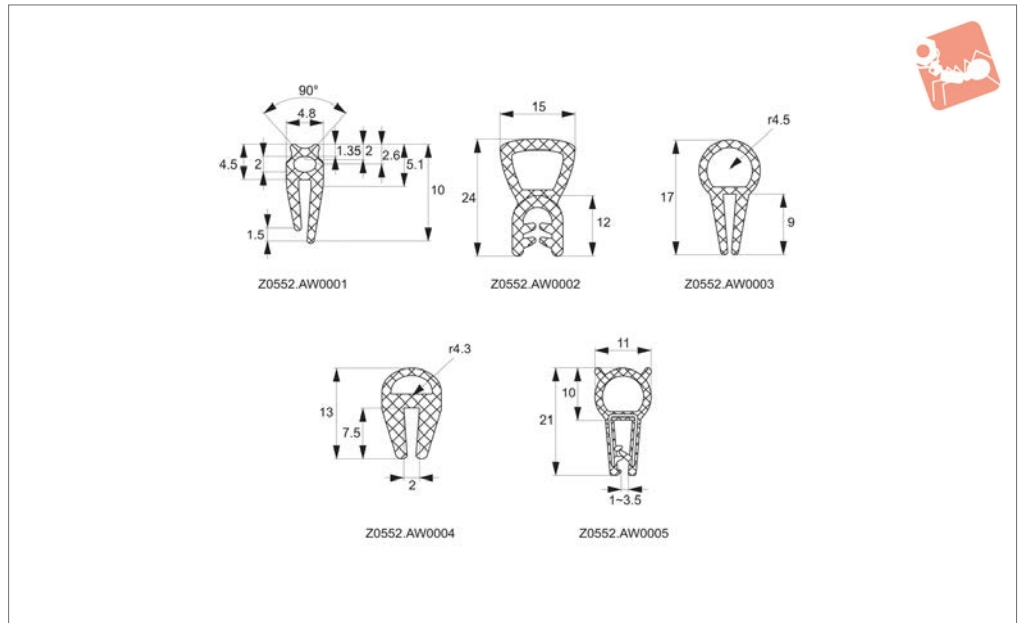

Material
EPDM, black.

Technical Notes
Supplied in 10m lengths as standard.

Larger lengths in multiples of 10m are available on request.

Tips
For properties of EPDM material see information in the plastics and rubbers table in our technical index.

Order No.	Material	Colour	Standard length m
Z0552.AW0001	EPDM	Black	10
Z0552.AW0002	EPDM	Black	10
Z0552.AW0003	EPDM	Black	10
Z0552.AW0004	EPDM	Black	10
Z0552.AW0005	EPDM	Black	10

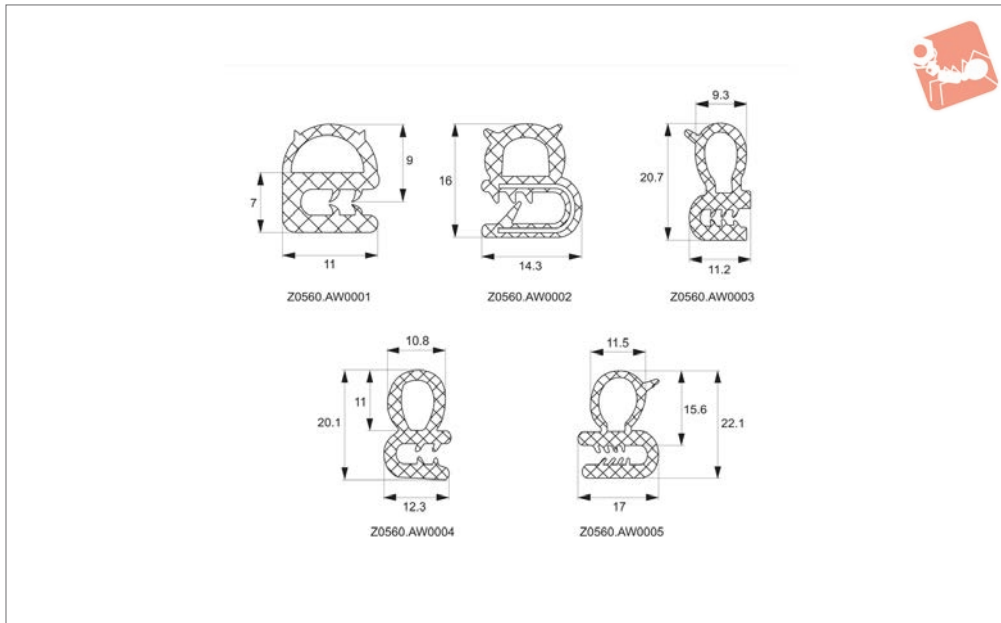

Z0560

GASKETING & DOCUMENT HOLDERS

Material

EPDM, black.

Larger lengths in multiples of 10m are available on request.

Information in the plastics and rubbers table in our technical index.

Technical Notes

Supplied in 10m lengths as standard.

Tips

For properties of EPDM material see information in the plastics and rubbers table in our technical index.

Important Notes

Price shown is per metre.

Order No.	Material	Colour	Grip range mm	Standard length m
Z0560.AW0001	EPDM	Black	1,0-2,0	10
Z0560.AW0002	EPDM	Black	1,0-2,0	10
Z0560.AW0003	EPDM	Black	1,0-1,5	10
Z0560.AW0004	EPDM	Black	1,0-2,0	10
Z0560.AW0005	EPDM	Black	1,0-1,5	10

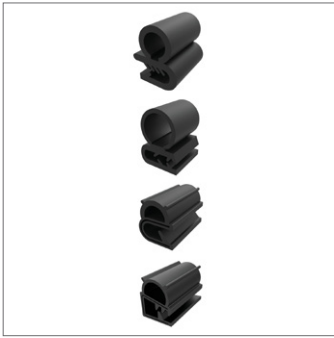

Z0562

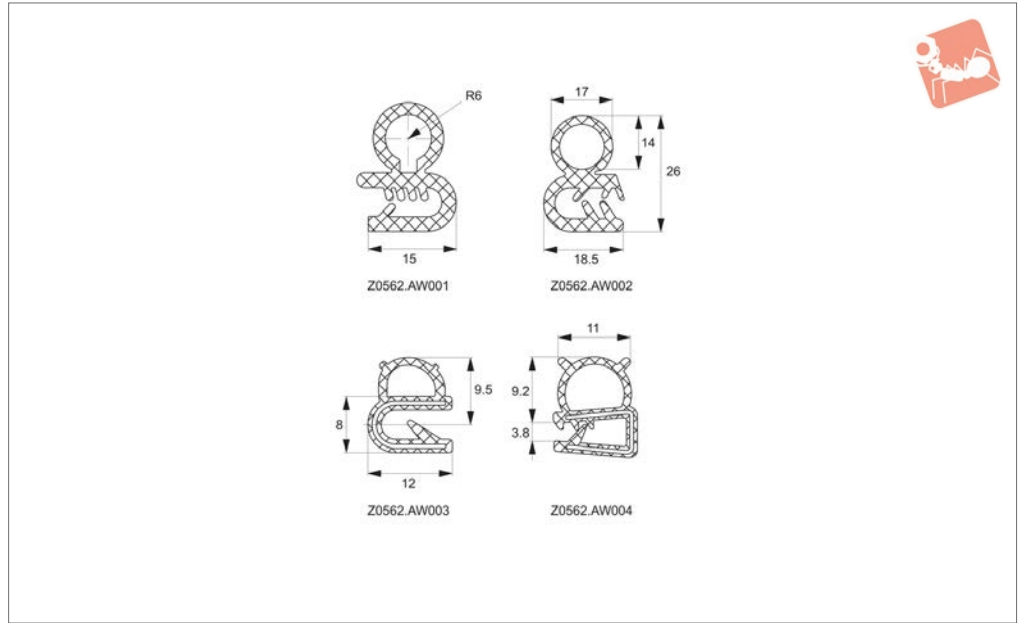

Material
EPDM, black.

Larger lengths in multiples of 10m are available on request.

Information in the plastics and rubbers table in our technical index.

Technical Notes
Supplied in 10m lengths as standard.

Tips
For properties of EPDM material see information in the plastics and rubbers table in our technical index.

Order No.	Material	Colour	Grip range mm	Standard length m
Z0562.AW0001	EPDM	Black	1,0-2,0	10
Z0562.AW0002	EPDM	Black	1,0-2,0	10
Z0562.AW0003	EPDM	Black	1,0-2,0	10
Z0562.AW0004	EPDM	Black	1,0-3,5	10

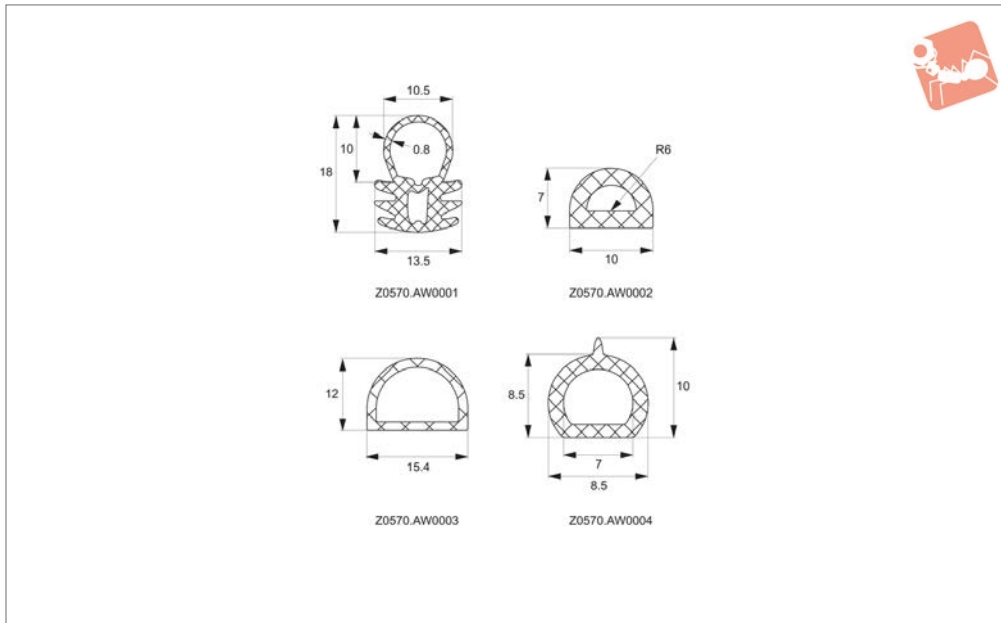

Z0570

GASKETING & DOCUMENT HOLDERS

Material

EPDM, black.

Larger lengths in multiples of 10m are available on request.

Information in the plastics and rubbers table in our technical index.

Technical Notes

Supplied in 10m lengths as standard.

Tips

For properties of EPDM material see information in the plastics and rubbers table in our technical index.

Order No.	Material	Colour	Standard length m
Z0570.AW0001	EPDM	Black	10
Z0570.AW0002	EPDM	Black	10
Z0570.AW0003	EPDM	Black	10
Z0570.AW0004	EPDM	Black	10



Z0590

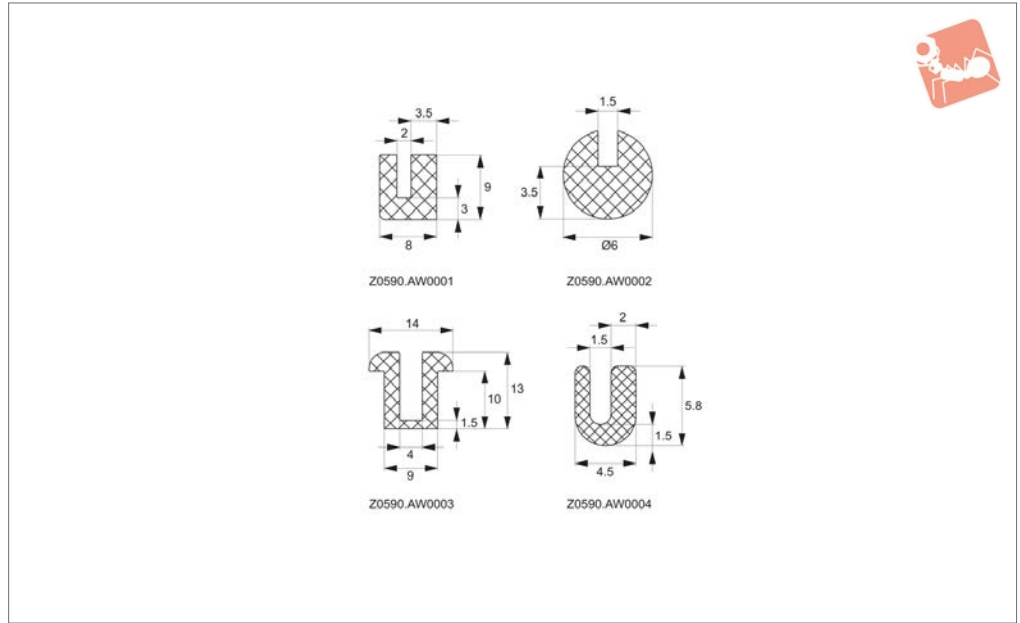

Material
EPDM, black.

Larger lengths in multiples of 10m are available on request.

Information in the plastics and rubbers table in our technical index.

Technical Notes
Supplied in 10m lengths as standard.

Tips
For properties of EPDM material see information in the plastics and rubbers table in our technical index.

Order No.	Material	Colour	Standard length m
Z0590.AW0001	EPDM	Black	10
Z0590.AW0002	EPDM	Black	10
Z0590.AW0003	EPDM	Black	10
Z0590.AW0004	EPDM	Black	10

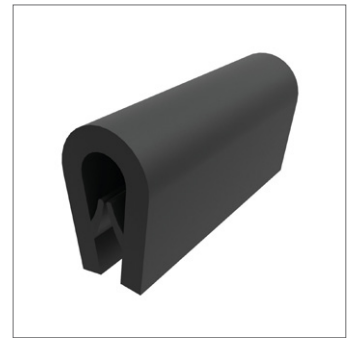
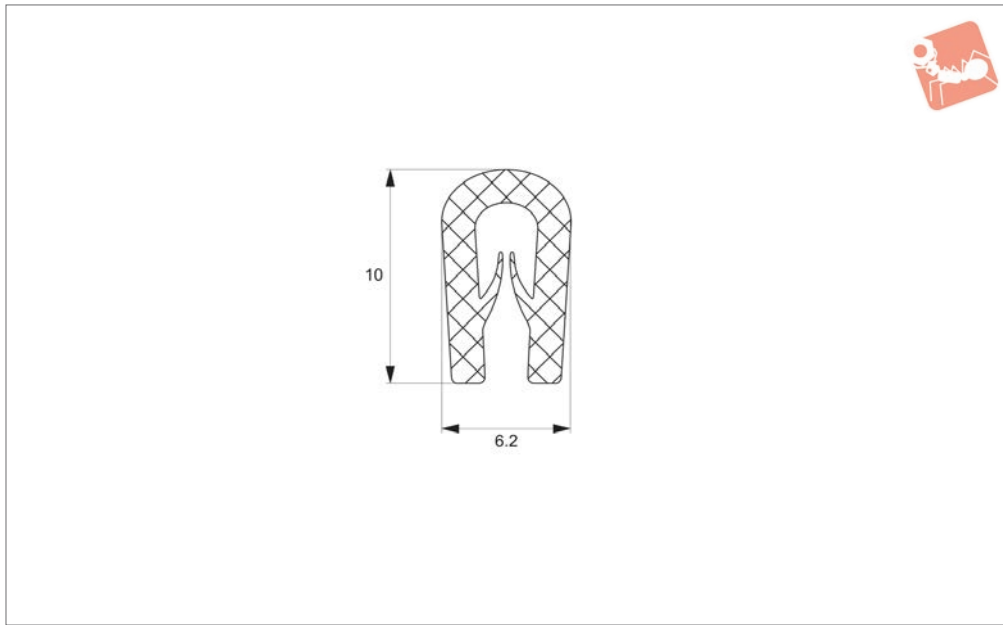

Z1002

GASKETING & DOCUMENT HOLDERS

Material

EPDM, black.

lengths in multiples of 10m are available on request.

mation in the plastics and rubbers table in our technical index.

Technical Notes

Can be supplied in 10m lengths. Larger

Tips

For properties of EPDM material see infor-

Order No.	Material	Colour	Grip range mm	Standard length m
Z1002.AW0001	EPDM	Black	1,0-2,0	10



We offer a wide range of gasketing and edge protection products;

- Self-adhesive foam.
- Edge protection.
- Flipper gaskets.
- Bubble gaskets.

They provide solutions for;

- Cabinet sealing.
- Vibration dampening.
- Edge protection.
- Dust exclusion.

In a wide range of applications;

- Electrical cabinet and panel manufacture.
- Generator, compressor and machinery manufacture.
- Heating and ventilation industries.
- Automotive and white goods.
- Furniture industry.



Explanation of minimum bending radius

Please refer to individual product tables for specific values.

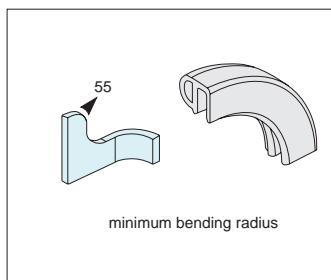

Outer curve

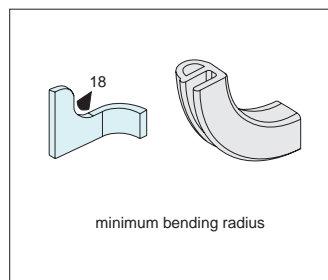

Inner curve

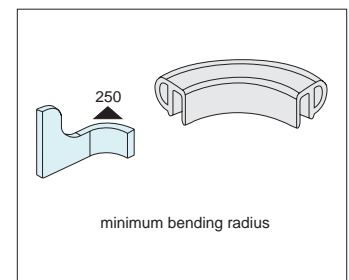

Outer radius

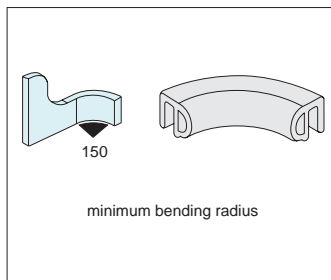

Inner radius

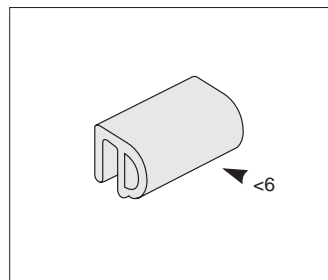

Compression