

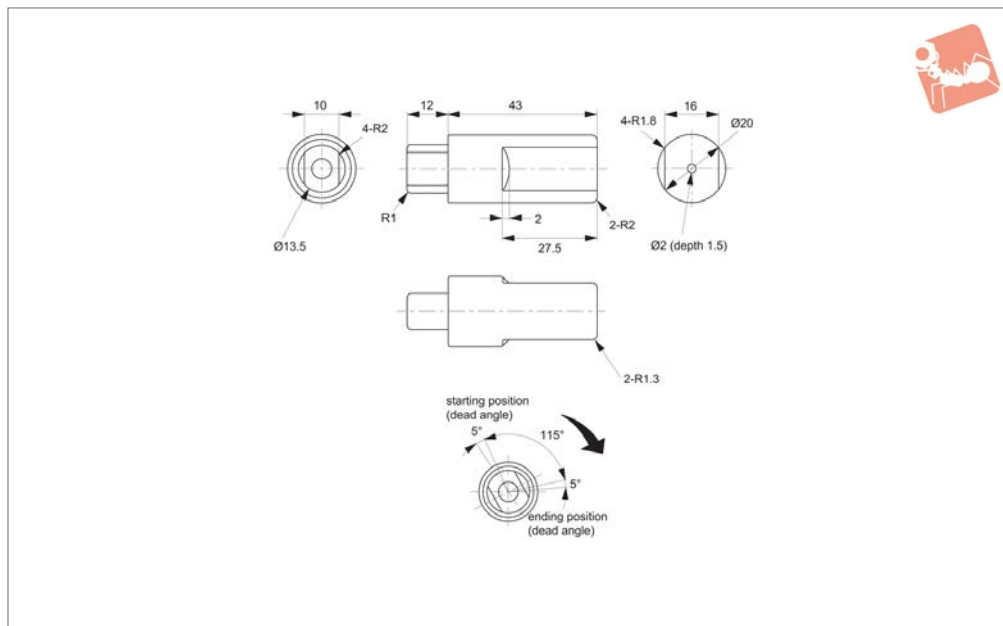

Torque Dampers

uni-directional - 115° operating angle

Torque Dampers



Q0400

TORQUE DAMPERS

Material

Body: stainless steel, AISI 304.
Shaft: PBT plastic. White for anti-clockwise version, grey for clockwise version. Different torque forces marked by colour coded dot on shaft.

Technical Notes

115° operating angle, additional 5° dead

angle at start/end position.
Tested to over 100,000 cycles.
Temperature range 0° to 40°C.

Tips

Provide smooth and quiet motion of lids, covers etc. Ideal for special purpose machines, air conditioning units etc.

Important Notes

Torque calculation:

$T \text{ (Kgf.cm)} = W \text{ (Kg)} \times 0.5 \times H \text{ (cm)}$.
W (Kg) is weight of cover/lid, H (cm) is distance between fulcrum and cover/lid's opening edge.

Order No.	Type	Shaft colour	Operating angle	Torque kgf/cm	Torque colour marking	Weight g
Q0400.AC0010	Anti-Clockwise	White	115°	15 - 25	Blue	38
Q0400.AC0020	Anti-Clockwise	White	115°	25 - 35	Red	38
Q0400.AC0110	Clockwise	Grey	115°	15 - 25	Blue	38
Q0400.AC0120	Clockwise	Grey	115°	25 - 35	Red	38

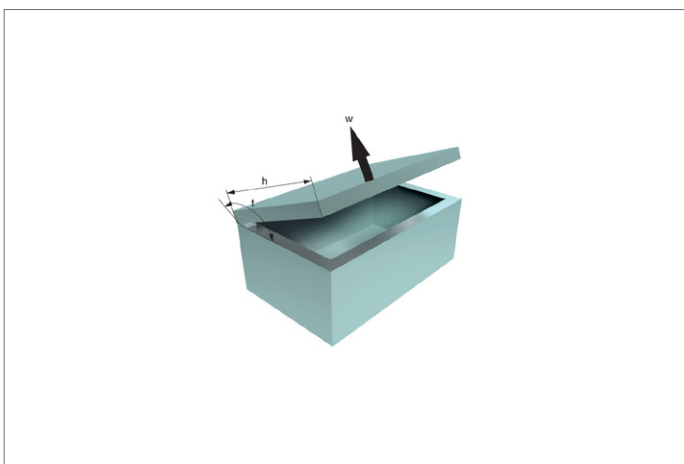



Q0420

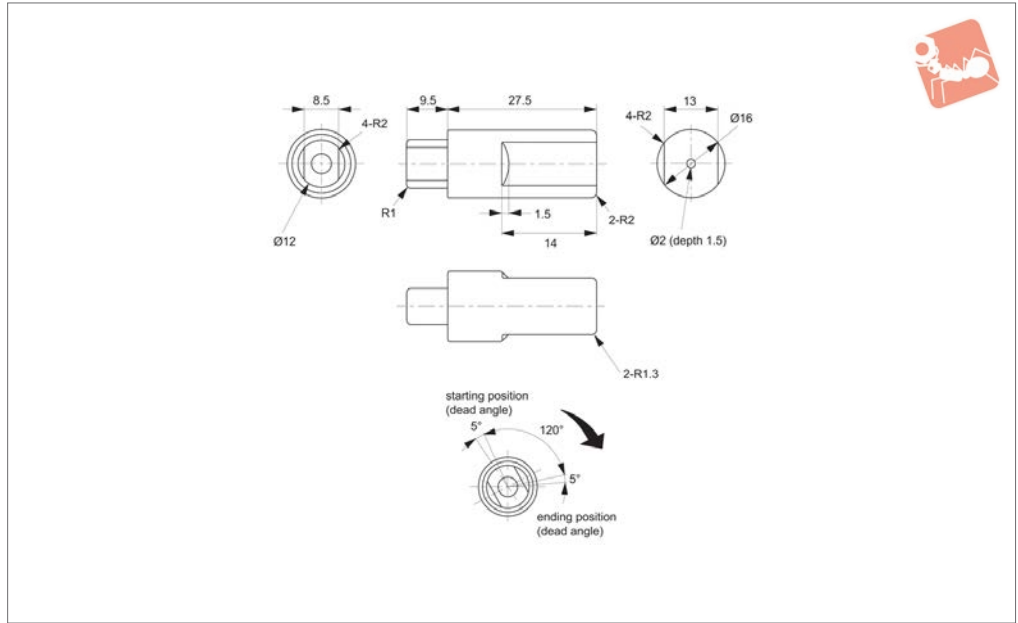

Material

Body: stainless steel, AISI 304.
 Shaft: PBT plastic. White for anti-clockwise version, grey for clockwise version. Different torque forces marked by colour coded dot on shaft.

Technical Notes

120° operating angle, additional 5° dead

angle at start/end position.
 Tested to over 100,000 cycles.
 Temperature range 0° to 40°C.

Tips

Provide smooth and quiet motion of lids, covers etc. Ideal for special purpose machines, air conditioning units etc.

Important Notes

Torque calculation:

$$T \text{ (Kgf.cm)} = W \text{ (Kg)} \times 0.5 \times H \text{ (cm)}$$

W (Kg) is weight of cover/lid, H (cm) is distance between fulcrum and cover/lid's opening edge.

Order No.	Type	Shaft colour	Operating angle	Torque kgf/cm	Torque colour marking	Weight g
Q0420.AW0010	Anti-Clockwise	White	120°	10,2 - 17,3	Green	16
Q0420.AW0020	Anti-Clockwise	White	120°	17,3 - 25,5	Black	16
Q0420.AW0110	Clockwise	Grey	120°	10,2 - 17,3	Green	16
Q0420.AW0120	Clockwise	Grey	120°	17,3 - 25,5	Black	16

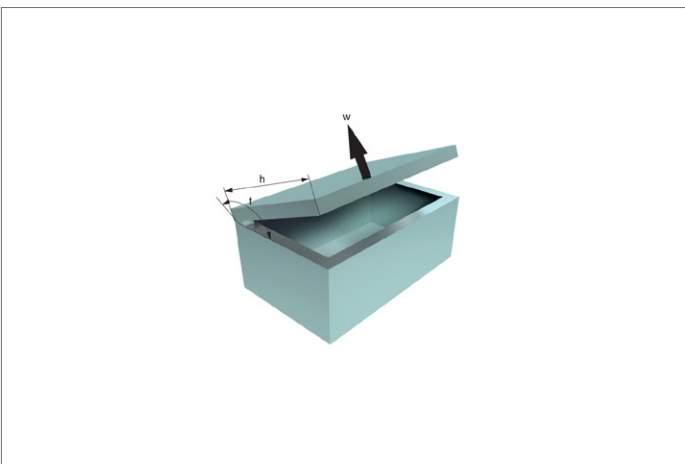



Torque Dampers - Compact uni-directional - 110° operating angle

Torque Dampers

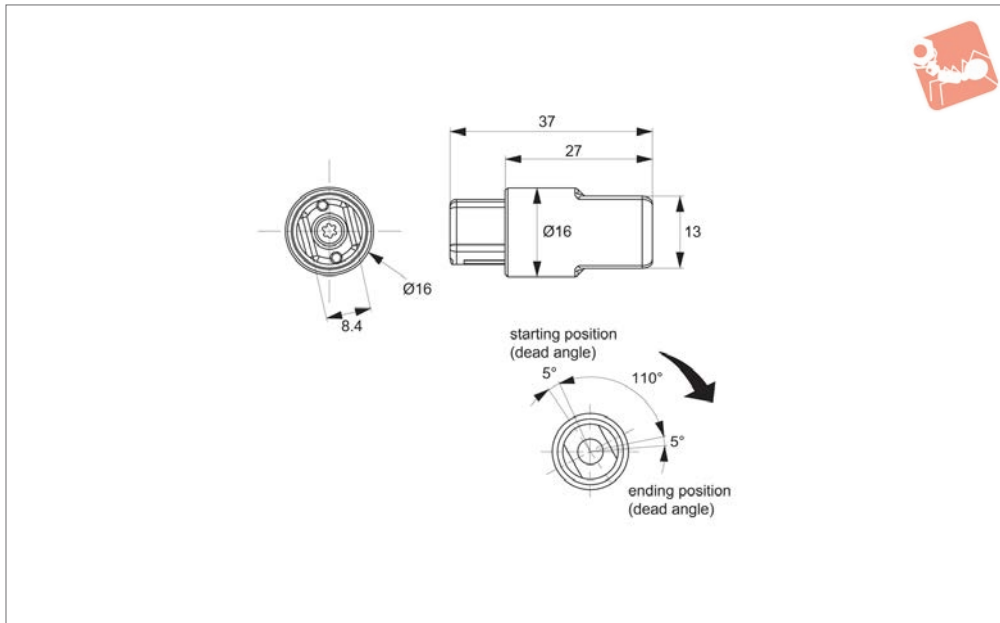

Q0422

TORQUE DAMPERS

Material

Body: stainless steel, AISI 304.
Shaft: POM plastic. White for anti-clockwise version, black for clockwise version.
Oil: silicone oil.

Tips

Provides smooth and quiet motion of lids, covers etc. Ideal for special purpose machines, air conditioning units etc.

Important Notes

Rated torques measured at rotation speed

of 20rpm, at 23°C.
Values ±20%.
Max. rotation speed 50rpm.
Max. cycle rate 10 cycle/min.
Operating temperature, -5° to 50°C.
Design tested to 50,000 cycles.

Torque calculation:

$T(\text{Kg.cm}) = W(\text{Kg}) \times H(\text{cm}) \times 9.8/2$.
W(Kg) is weight of cover/lid, H(cm) is distance between fulcrum and cover/lid's opening edge.

Q0422 is designed to generate a large torque just before a lid, closing from a vertical position; comes to full closure. See diagram a.

Q0422 should not be used for a lid closing from a horizontal start position, as the damper torque generated, just prior to closing, is too great causing the lid not to fully close. See diagram b.

Order No.	Damping direction	Shaft colour	Operating angle	Torque kgf	Weight g
Q0422.AW0110	Clockwise	Black	110°	10	14
Q0422.AW0010	Anti-clockwise	White	110°	10	14
Q0422.AW0120	Clockwise	Black	110°	20	14
Q0422.AW0020	Anti-clockwise	White	110°	20	14
Q0422.AW0130	Clockwise	Black	110°	30	14
Q0422.AW0030	Anti-clockwise	White	110°	30	14

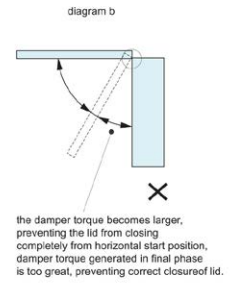
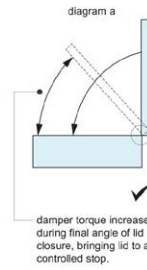
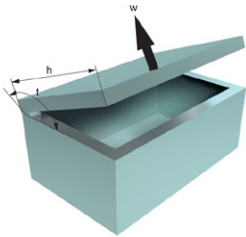



Torque Dampers

uni-directional - 125° operating angle

Torque Dampers

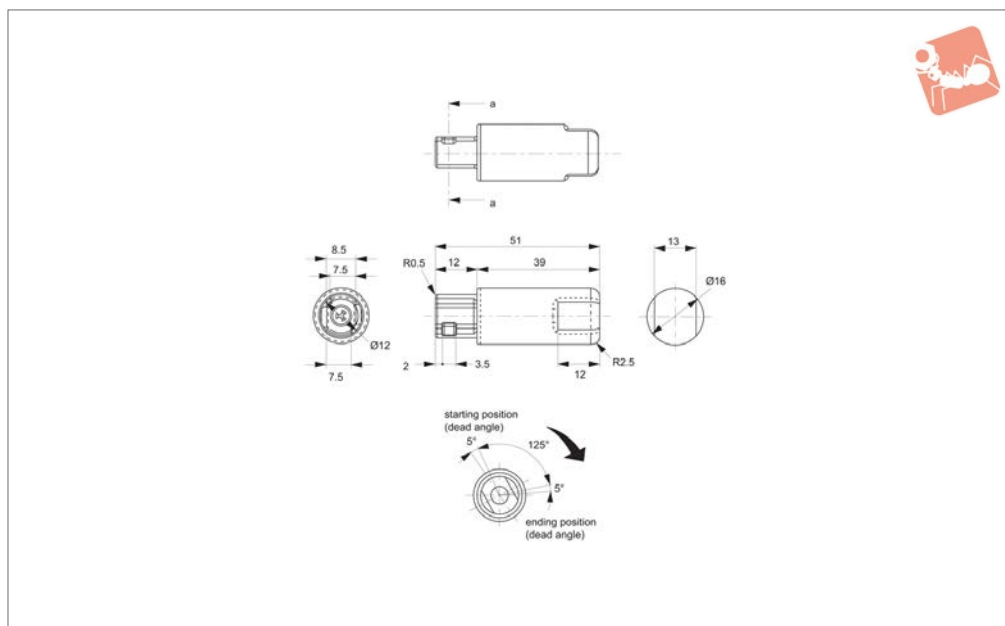

Q0430

TORQUE DAMPERS

Material

Body: stainless steel, AISI 304.
Shaft: PBT plastic. White for anti-clockwise version, grey for clockwise version. Different torque forces marked by colour coded dot on shaft.

Technical Notes

125° operating angle, additional 5° dead

angle at start/end position.
Tested to over 100,000 cycles.
Temperature range 0° to 40°C.

Tips

Provide smooth and quiet motion of lids, covers etc. Ideal for special purpose machines, air conditioning units etc.

Important Notes

Torque calculation:

$T \text{ (Kgf.cm)} = W \text{ (Kg)} \times 0.5 \times H \text{ (cm)}$.
W (Kg) is weight of cover/lid, H (cm) is distance between fulcrum and cover/lid's opening edge.

Order No.	Type	Shaft colour	Operating angle	Torque colour marking	Damping torque kgf/cm	Weight g
Q0430.AC0010	Anti-Clockwise	White	125°	Blue	20,4 - 26,5	20
Q0430.AC0020	Anti-Clockwise	White	125°	Red	24,5 - 30,6	20
Q0430.AC0110	Clockwise	Grey	125°	Blue	20,4 - 26,5	20
Q0430.AC0120	Clockwise	Grey	125°	Red	24,5 - 30,6	20

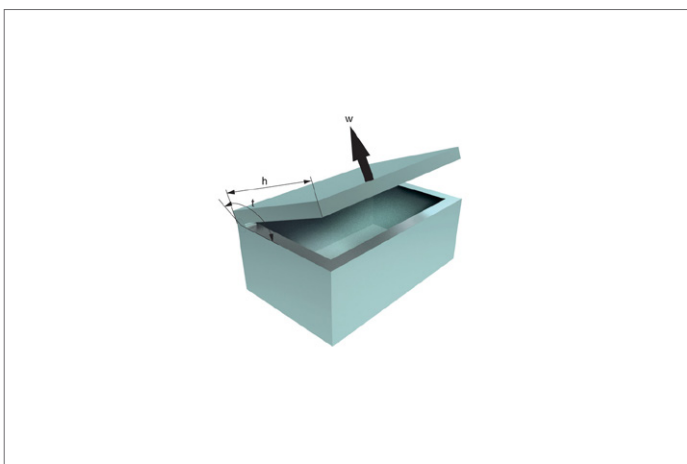

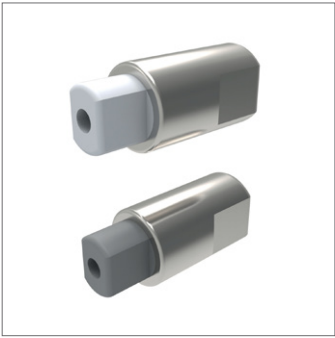

Q0440

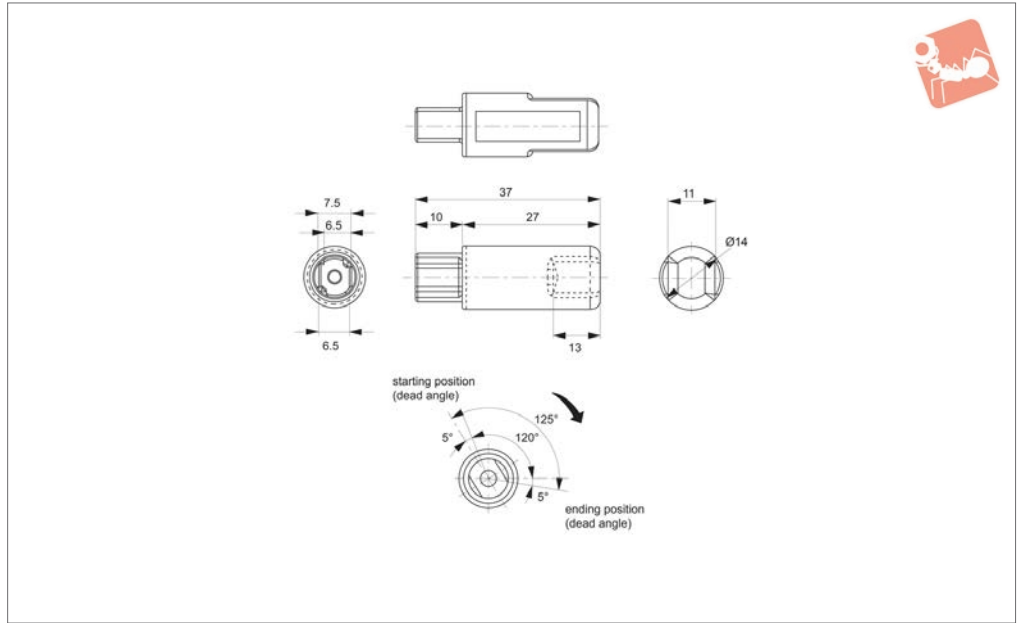

Material

Body: stainless steel, AISI 304. Shaft: PBT plastic. White for anti-clockwise version, grey for clockwise version. Different torque forces marked by colour coded dot on shaft.

Technical Notes

120° operating angle, additional 5° dead

angle at start/end position.

Tested to over 100,000 cycles.
Temperature range 0° to 40°C.

Tips

Provide smooth and quiet motion of lids, covers etc. Ideal for special purpose machines, air conditioning units etc.

Important Notes

Torque calculation:

$$T \text{ (Kgf.cm)} = W \text{ (Kg)} \times 0.5 \times H \text{ (cm)}$$

W (Kg) is weight of cover/lid, H (cm) is distance between fulcrum and cover/lid's opening edge.

Order No.	Type	Shaft colour	Operating angle	Torque colour marking	Torque Ncm	Weight g
Q0440.AC0010	Anti-Clockwise	White	120°	Blue	8,2 - 15,3	10
Q0440.AC0020	Anti-Clockwise	White	120°	Red	15,3 - 25,5	10
Q0440.AC0110	Clockwise	Grey	120°	Blue	8,2 - 15,3	10
Q0440.AC0120	Clockwise	Grey	120°	Red	15,3 - 25,5	10





Torque Dampers - Compact uni-directional - 110° operating angle

Torque Dampers

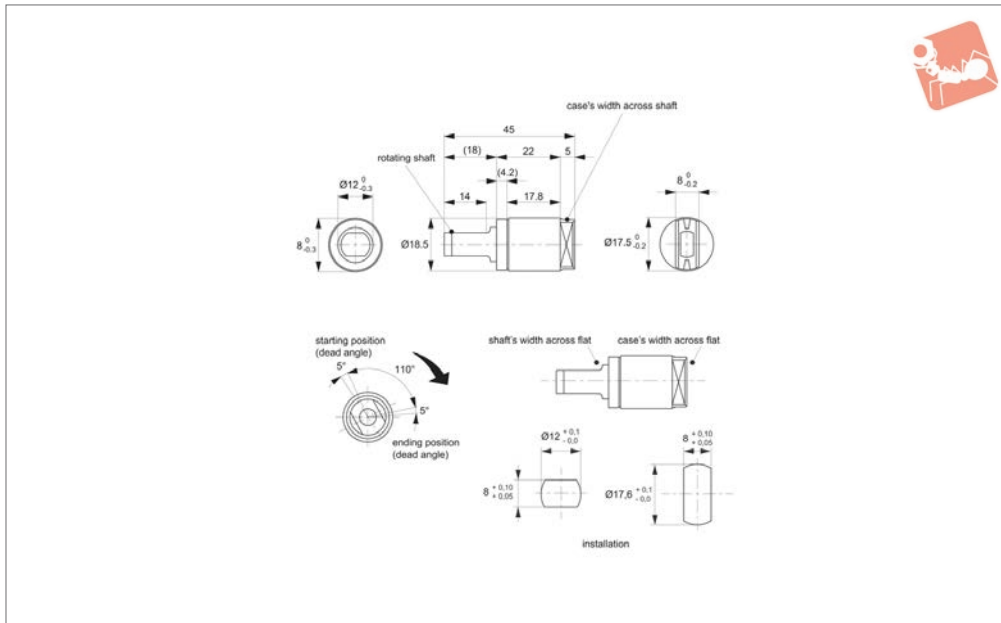

Q0460

TORQUE DAMPERS

Material

Body: polybutylene terephthalate (PBT).
Shaft: polybutylene sulphide (PPS). White for anti-clockwise version, black for clockwise version.
Oil: silicone oil.

Tips

Provides smooth and quiet motion of lids, covers etc. Ideal for special purpose machines, air conditioning units etc.

Important Notes

Rated torques measured at rotation speed

of 20rpm, at 23°C.
Values $\pm 20\%$.
Max. rotation speed 50rpm.
Max. cycle rate 10 cycle/min.
Operating temperature, -5° to 50°C.
Design tested to 50,000 cycles.

Torque calculation:

$T(\text{Kgf.cm}) = W(\text{Kg}) \times H(\text{cm}) \times 9.8/2$.
W(Kg) is weight of cover/lid, H(cm) is distance between fulcrum and cover/lid's opening edge.

Q0460 is designed to generate a large torque just before a lid, closing from a vertical position; comes to full closure. See diagram a.

Q0460 should not be used for a lid closing from a horizontal start position, as the damper torque generated, just prior to closing, is too great causing the lid not to fully close. See diagram b.

Order No.	Damping direction	Shaft colour	Operating angle	Damping torque kgf/cm	Return damping torque kgf/cm	Weight g
Q0460.AW0110	Clockwise	Black	110°	10	3	10
Q0460.AW0010	Anti-clockwise	White	110°	10	3	10
Q0460.AW0115	Clockwise	Black	110°	15	5	10
Q0460.AW0015	Anti-clockwise	White	110°	15	5	10
Q0460.AW0118	Clockwise	Black	110°	18	8	10
Q0460.AW0018	Anti-clockwise	White	110°	18	8	10

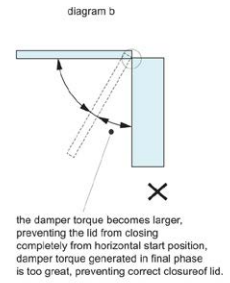
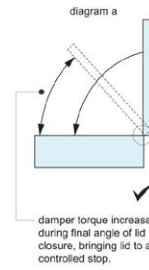
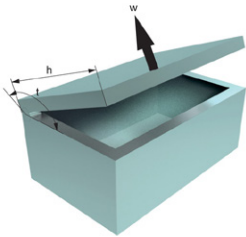



Torque Dampers - Compact with keyway - uni-directional - 110° operating

Torque Dampers

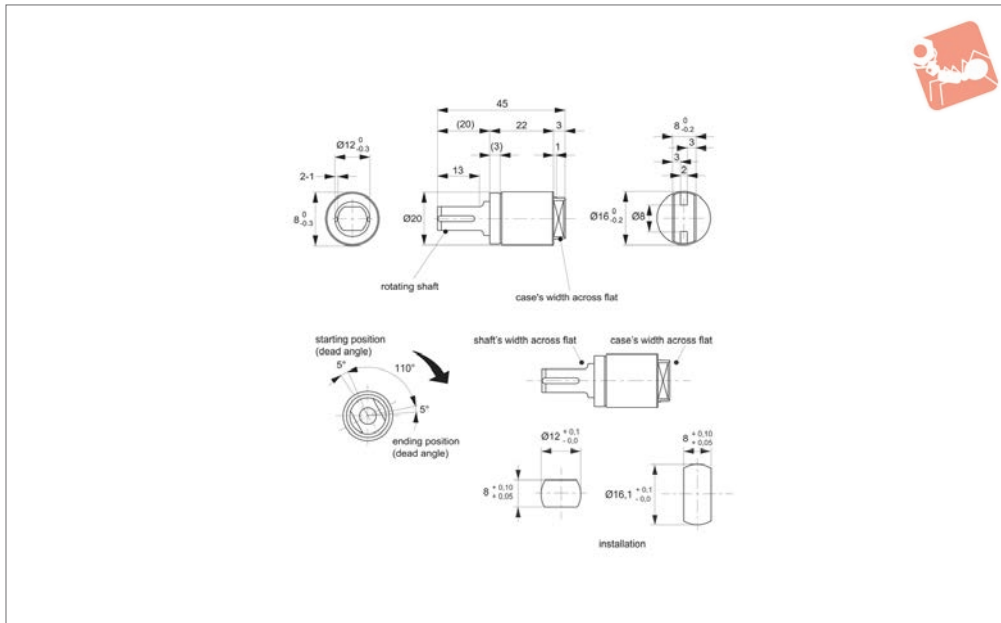

Q0462

TORQUE DAMPERS

Material

Body: polybutylene terephthalate (PBT).
Shaft: polybutylene sulphide (PPS). White for anti-clockwise version, black for clockwise version.
Oil: silicone oil.

Tips

Provides smooth and quiet motion of lids, covers etc. Ideal for special purpose machines, air conditioning units etc.

Important Notes

Rated torques measured at rotation speed

of 20rpm, at 23°C. Values ±20%. Max. rotation speed 50rpm. Max cycle rate 10 cycle/min. Operating temperature, -5° to 50°C. Design tested to 50,000 cycles. Meets RoHS standards.

Torque calculation:

$T(\text{Kgf.cm}) = W(\text{Kg}) \times H(\text{cm}) \times 9.8/2$.
W(Kg) is weight of cover/lid, H(cm) is distance between fulcrum and cover/lid's opening edge.

Q0462 is designed to generate a large

torque just before a lid, closing from a vertical position; comes to full closure. See diagram a.

Q0462 should not be used for a lid closing from a horizontal start position, as the damper torque generated, just prior to closing, is too great causing the lid not to fully close. See diagram b.

Order No.	Damping direction	Shaft colour	Operating angle	Damping torque kgf/cm	Return damping torque kgf/cm	Weight g
Q0462.AW0110	Clockwise	Black	110°	10	2	12
Q0462.AW0010	Anti-clockwise	White	110°	10	2	12
Q0462.AW0120	Clockwise	Black	110°	20	4	12
Q0462.AW0020	Anti-clockwise	White	110°	20	4	12
Q0462.AW0130	Clockwise	Black	110°	30	8	12
Q0462.AW0030	Anti-clockwise	White	110°	30	8	12

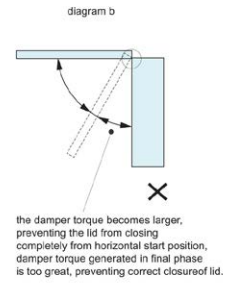
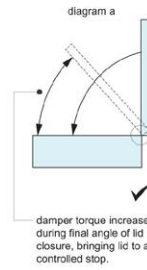
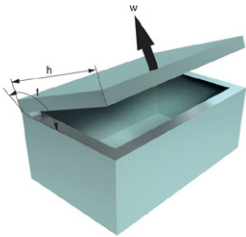



Soft Closing Hinge Set - Complete with torque dampers - 115° operating angle

Torque Dampers

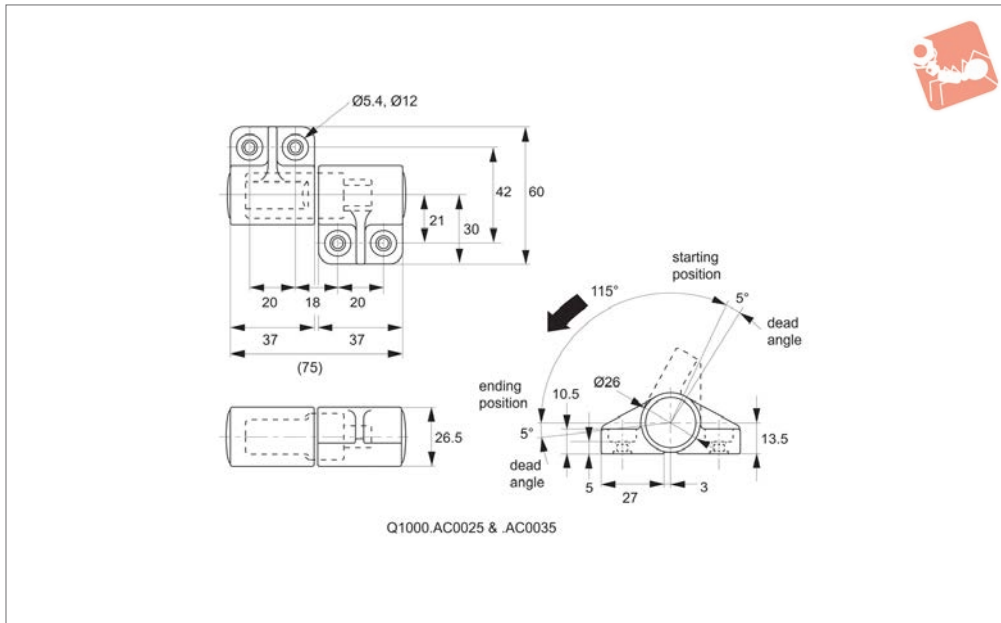

Q1000

TORQUE DAMPERS

Material

Body: stainless steel, AISI 304.
Pin: PBT plastic. Bracket: PBT plastic with polypropylene cap.

Technical Notes

115° operating angle, additional 5° dead angle at start/end position.
Tested to over 100,000 cycles.

Temperature range -20° to 60°C.

Tips

Provide smooth and quiet motion of lids, covers etc. Ideal for special purpose machines, air conditioning units etc. For further details of torque damper used in hinge refer to part Q0400. Sold as a matching pair (left/right).

Important Notes

Torque calculation:

$T \text{ (Kgf.cm)} = W \text{ (Kg)} \times 0.5 \times H \text{ (cm)}$.
W (Kg) is weight of cover/lid, H (cm) is distance between fulcrum and cover/lid's opening edge.

Order No.	Damping direction	Contains damper	Operating angle	Torque/pair kgf/cm
Q1000.AC0025	1 x Clockwise 1 x Anti-Clockwise	1 off Q0400.AC0010 & Q0400.AC0110	115°	30 - 50
Q1000.AC0035	1 x Clockwise 1 x Anti-Clockwise	1 off Q0400.AC0020 & Q0400.AC0120	115°	50 - 70

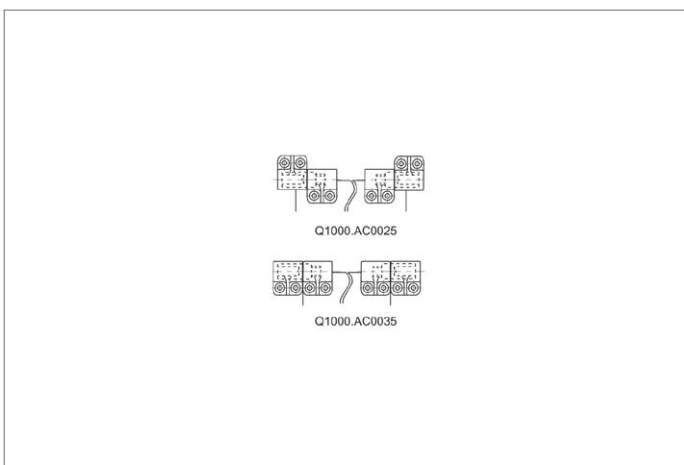



Q1002

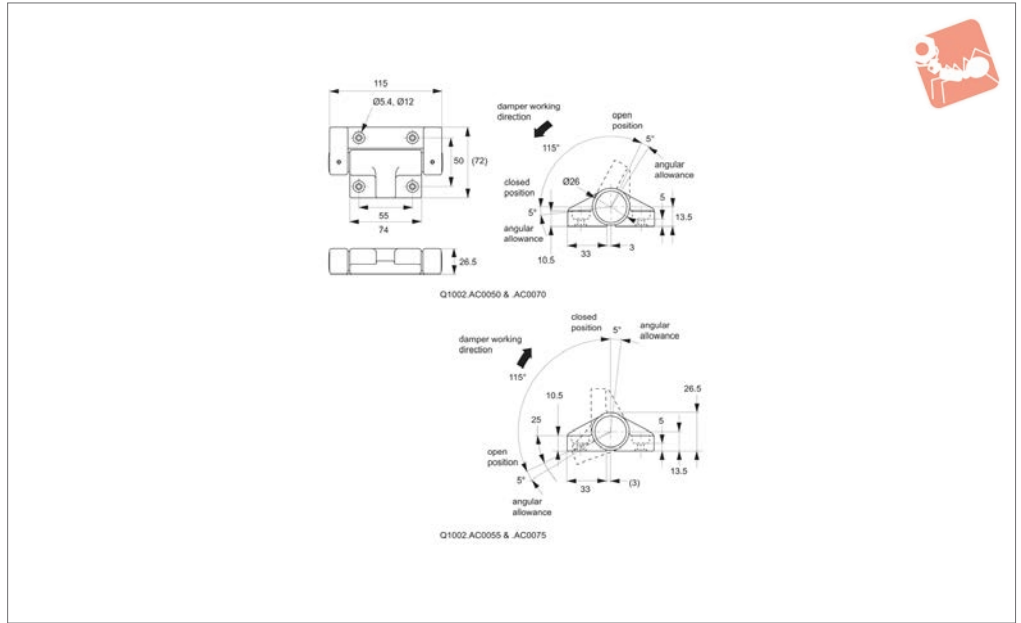

Material

Body: stainless steel, AISI 304. Pin: PBT plastic.
Bracket: PBT plastic with polypropylene cap.

Technical Notes

115° operating angle, additional 5° dead angle at start/end position.

Tested to over 100,000 cycles.
Temperature range -20° to 60°C.

Tips

Provide smooth and quiet motion of lids, covers etc. Ideal for special purpose machines, air conditioning units etc.
For further details of torque damper used in hinge refer to part Q0400.

Sold as individual piece.

Important Notes

Torque calculation:

$T \text{ (Kgf.cm)} = W \text{ (Kg)} \times 0.5 \times H \text{ (cm)}$.
W (Kg) is weight of cover/lid, H (cm) is distance between fulcrum and cover/lid's opening edge.

Order No.	Damping direction	Contains damper	Damping action	Operating angle	Torque/pair kgf/cm
Q1002.AC0050	Anti-Clockwise	1 off Q0400.AC0010 & Q0400.AC0110	Closing	115°	60 - 100
Q1002.AC0055	Anti-Clockwise	1 off Q0400.AC0010 & Q0400.AC0110	Opening	115°	60 - 100
Q1002.AC0070	Clockwise	1 off Q0400.AC0020 & Q0400.AC0120	Closing	115°	100 - 140
Q1002.AC0075	Clockwise	1 off Q0400.AC0020 & Q0400.AC0120	Opening	115°	100 - 140

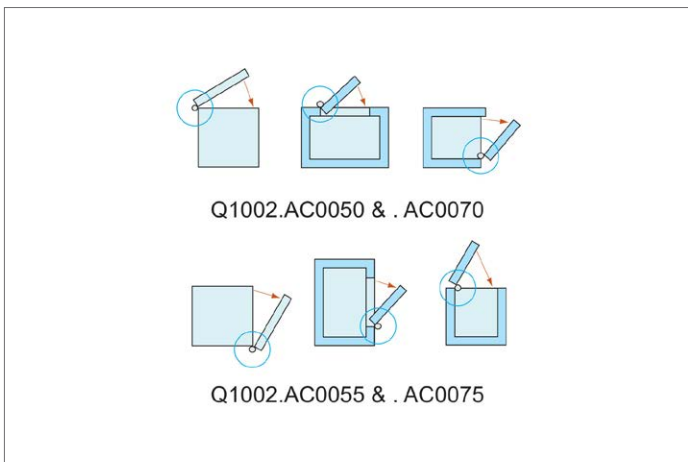



Soft Closing Hinge Set - Complete with torque dampers - 115° operating angle

Torque Dampers

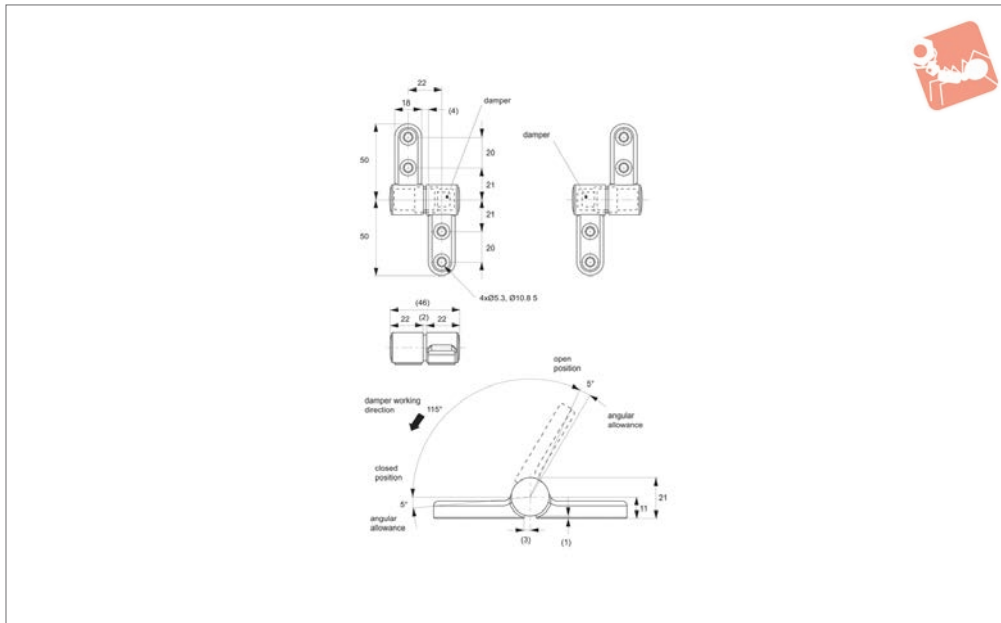

Q1010

TORQUE DAMPERS

Material

Body: stainless steel, AISI 316.

Technical Notes

Soft closing damper hinge prevents lids from slamming shut. 115° operating, additional 5° dead angle at start/end posi-

tion. Temperature range 0° to 40°C.

Tips

For further details of torque damper used in hinge refer to part Q0440. Sold as a matching pair (left/right).

Important Notes

Torque calculation:

$T \text{ (Kgf.cm)} = W \text{ (Kg)} \times 0.5 \times H \text{ (cm)}$.
W (Kg) is weight of cover/lid, H (cm) is distance between fulcrum and cover/lid's opening edge.

Order No.

Q1010.AC0050

Contains damper

1 off Q0440.AC0010 & Q0440.AC0110

Torque/pair

kgf/cm
30 - 51

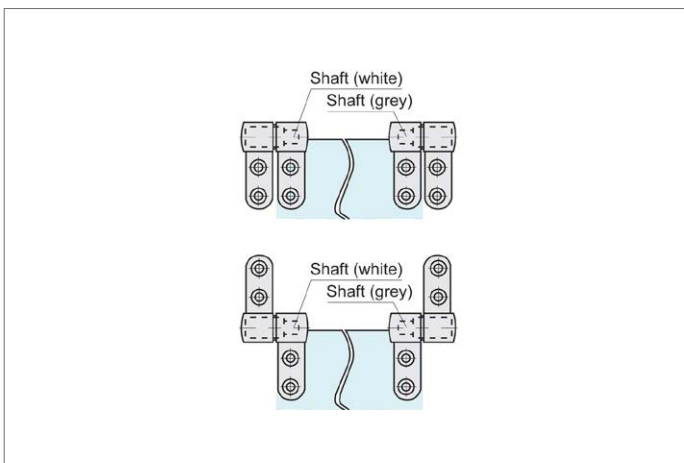



Q1050

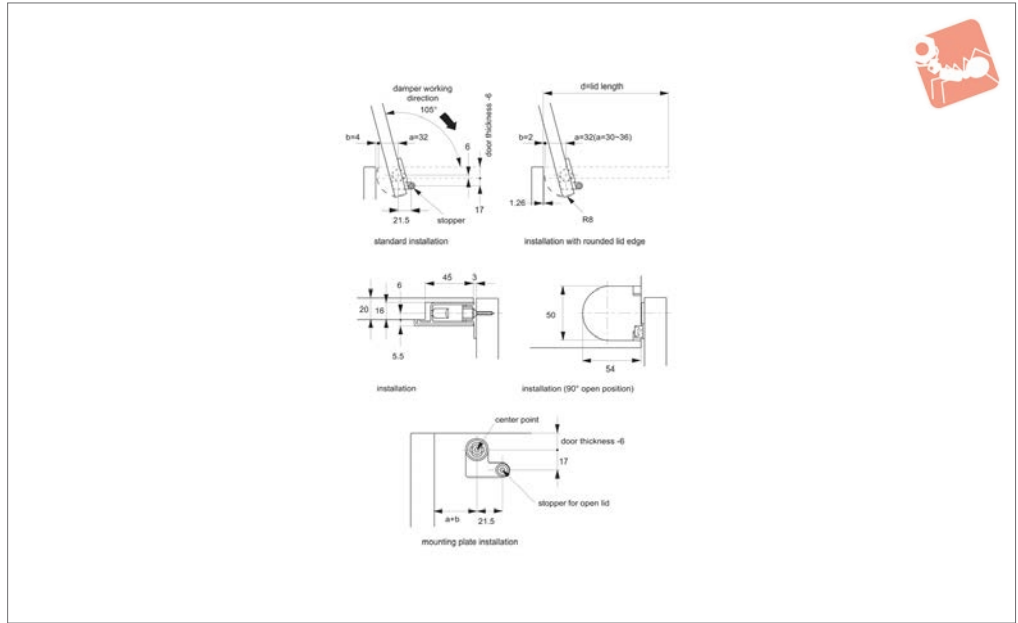

TORQUE DAMPERS

Material

Hinge mounting plate: aluminium, black.
Hinge bracket: polyacetal, black.
Face plate: ABS plastic, black or white finish.

Technical Notes

Soft closing damper hinge prevents lids

from slamming shut. 115° operating angle, additional 5° dead angle at start/end position. Temperature range 0° to 40°C.

Tips

For further details of torque damper used in hinge refer to part Q0420.

Sold as matching pair (left/right).

Important Notes

Torque calculation:

$$T \text{ (Kgf.cm)} = W \text{ (Kg)} \times 0.5 \times H \text{ (cm)}$$

W (Kg) is weight of cover/lid, H (cm) is distance between fulcrum and cover/lid's opening edge.

Order No.	Type	Contains damper	Finish	Torque/pair kgf/cm	Weight/pair g
Q1050.AC0035	Hinge	1 off Q0420.AC0010 & Q420.AC0110	Black	20 - 34	91
Q1050.AC0050	Hinge	1 off Q0420.AC0020 & Q420.AC0120	Black	34 - 50	91
Q1050.AC9010	Face Plate	-	Black	-	12
Q1050.AC9020	Face Plate	-	White	-	12

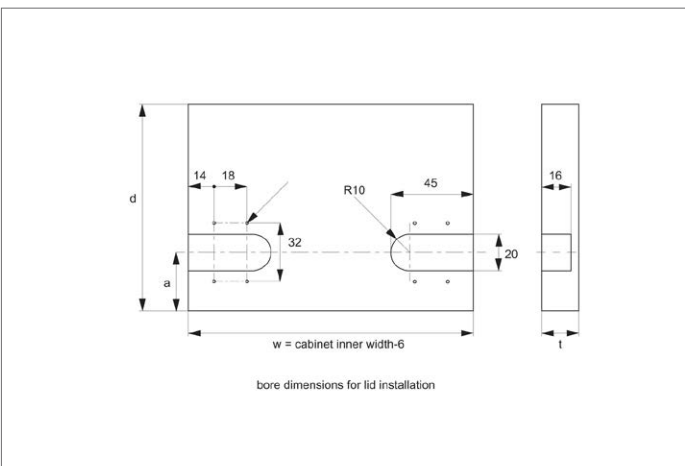



Soft Closing Hinge Set - Complete

with torque dampers - 115° operating angle

Torque Dampers

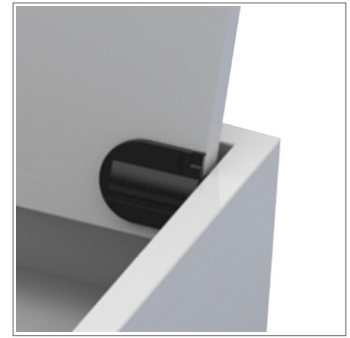
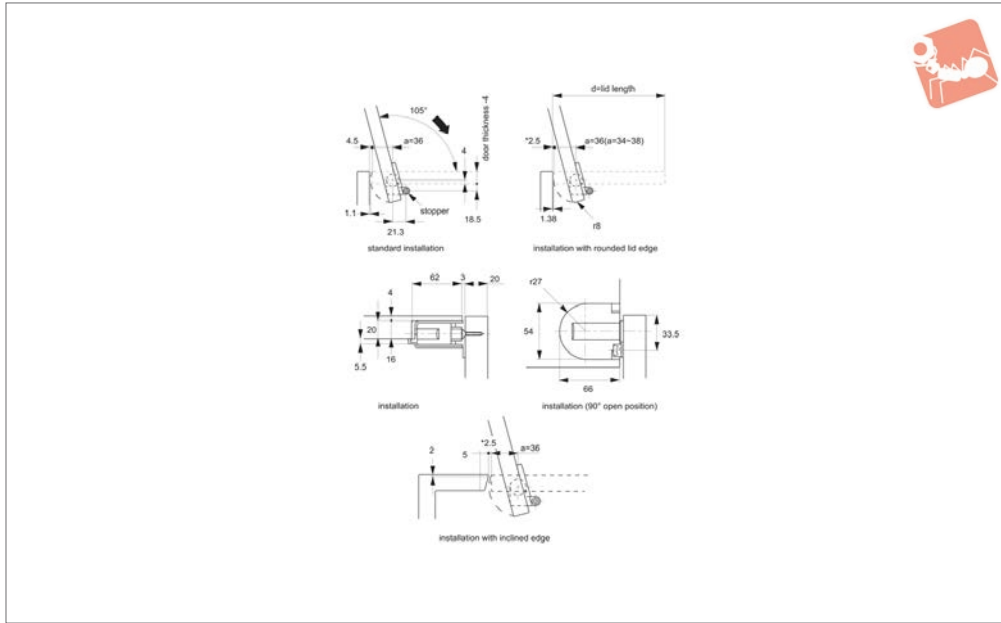

Q1060

TORQUE DAMPERS

Material

Hinge mounting plate: aluminium, black.
 Hinge bracket: polyacetal, black.
 Face plate: ABS plastic, black or white finish.

Technical Notes

Soft closing damper hinge prevents lids from slamming shut. 115° operating

angle, additional 5° dead angle at start/end position. Temperature range 0° to 40°C.

Please note the hinge itself is black for both models. The cover plate is either black or white.

Tips

For further details of torque damper used

in hinge refer to part Q0420. Sold as matching pair (left/right).

Important Notes

Torque calculation:

$T \text{ (Kgf.cm)} = W \text{ (Kg)} \times 0.5 \times H \text{ (cm)}$.
 W (Kg) is weight of cover/lid, H (cm) is distance between fulcrum and cover/lid's opening edge.

Order No.	Type	Contains damper	Finish	Torque/pair kgf/cm	Weight/pair g
Q1060.AC0080	Hinge	1 off Q0420.AC0010 & Q0420.AC0110	Black	61 - 81	103
Q1060.AC0180	Hinge	1 off Q0420.AC0010 & Q0420.AC0110	White	61 - 81	103

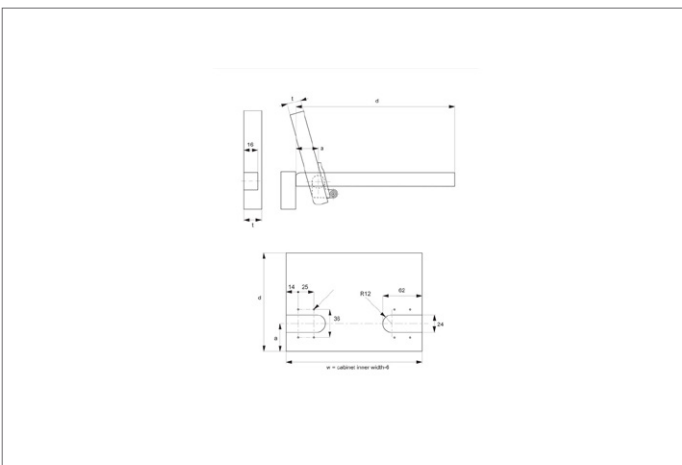



Wixroyd torque dampers offer controlled opening and closing of lids, drawers, covers and much more, they provide a wide range of solutions for a variety of applications creating smooth movement and function.

Though unnoticed in many applications, torque dampers are a vital part of many products bringing quality, safety and durability. Torque dampers provide quality movement enhancing both touch and feel.

Operating principle

Torque dampers utilise the movement of fluid forced from one chamber to another via a rotor. Dampening speed is dependent upon the viscosity of the fluid and the diameter of the fluid aperture.

Torque calculation

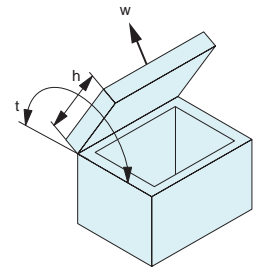

To calculate the torque for your application, the following measurements are necessary.

t (torque) = $w \times 0.5 \times h$
 h = length from pivot point to end of lid (cm)
 w = weight of the lid (Kg)



Torque force stated per product (see individual product pages), is the maximum torque to which the specified part can be exposed before the dampening force yields and hence dampening is overcome.

Table of torque dampers: Torque ranges

Part no.	Torque damper range	Torque Kgf.cm	Torque Kgf.cm																				
			10	20	30	40	50	60	70	80	90	100	110	120	130	140	150						
 Q0400		15 - 35																					
 Q0420		10 - 25																					
 Q0422		10 - 35																					
 Q0430		20 - 30																					
 Q0440		8 - 25																					
 Q0460		10 - 18																					
 Q0462		10 - 30																					
 Q1000		30 - 70																					
 Q1002		60 - 140																					
 Q1010		30 - 50																					
 Q1050		20 - 50																					
 Q1060		61 - 81																					